

SIMPA

即熱式氣體熱水爐
Instantaneous Gas Water Heater

型號： RS68B / RS10B / RS10BV
Model :

使用說明書
User Instructions

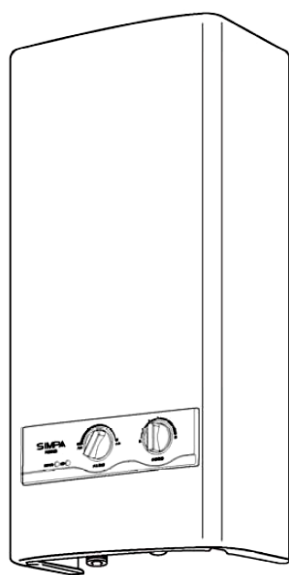

RS68B

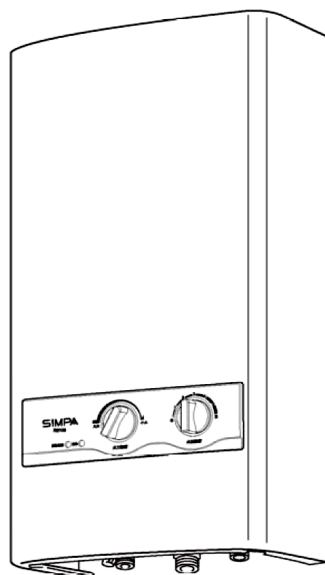

RS10B

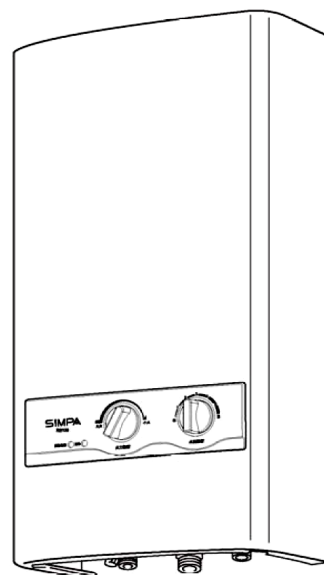

RS10BV

香港煤氣適用
For Hong Kong Town Gas

目錄



重要安全指示	第 1 頁
產品介紹	第 5 頁
操作指示	第 7 頁
保養	第 10 頁
故障處理	第 10 頁
規格	第 11 頁

注意!

根據香港氣體安全規例，任何氣體裝置工程，包括爐具和接駁喉管的安裝，必須由註冊氣體裝置技工執行，而該技工已於相關的氣體工程類別註冊及受聘於註冊氣體工程承辦商。

重要安全指示

為安全使用本爐具，請遵照下列各項指示。下列指示對安全有莫大關係，符號及其意思如下：

 危險	若忽視此符號，並錯誤使用爐具，可能引致死亡或嚴重受傷和發生火警的危險。
 警告	若忽視此符號，並錯誤使用爐具，可能引致死亡或嚴重受傷，亦可導致火警發生。
 注意	若忽視此符號，並錯誤使用爐具，可能會引致受傷和財物損毀。

上述描述所導致的受傷及財物損毀情況，請參考下列詳細描述。

- 受傷：出現損傷、燙傷及觸電等情況，並須送院治理或長期留院治療。
- 財物損毀：對房屋及傢俱等物件造成廣泛損毀。

本說明書中包含不同符號，請參考下列有關符號意思的描述。



危險、警告、
注意



禁止



切勿觸摸



必須執行



切勿拆開



必須接到地線



危險

若發現本爐具出現以下問題



- 當使用爐具時，若發現異常的火焰、氣味或特別的聲音，請立即關閉熱水水龍頭及煤氣錶掣，並通知煤氣公司安排檢修。
- 在發生地震或火災時，請立即停止操作爐具。



1. 關閉熱水水
龍頭

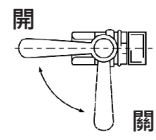

2. 關閉煤氣錶掣



切勿將排氣管的出口置於室內

- 排氣管的出口必須面向室外地方。

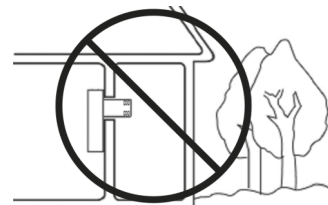

重要安全指示

⚠ 危險

! 若你發覺有煤氣洩漏

1. 請停止使用本爐具，並關閉煤氣錶掣。

2. 開啟所有窗戶讓煤氣排出屋外。

3. 使用位於室外的電話與煤氣公司緊急事故熱線 2880 6999 聯絡。

關閉水龍頭



關閉煤氣錶掣

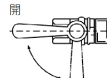

若發生燃氣洩漏

- 切勿點燃明火、插拔電源插頭。
- 禁止開啟或關閉電器產品。
- 切勿在附近使用電話、手機。



當發覺有燃氣洩漏，切勿進行上述事項，直至維修工作完成為止。

切勿在漏氣處理完畢前進行上述活動及再次打開煤氣錶掣。

⚠ 警告

請小心看管兒童

- ! 注入熱水到浴缸時，切勿讓兒童在浴室玩耍，以免兒童不小心掉進浴缸或導致預計不到的意外發生。
- 切勿讓兒童於沒有成人監督下洗澡。

嚴禁自行拆卸、維修或改裝爐具

- ! 爐具的安裝、維修及其他附帶工程，必須由受僱於註冊氣體工程承辦商及領有適當類別的氣體裝置工程技工進行，以免造成危險或損毀爐具。

切勿遮蓋排氣管出口

- ! 請勿因增建或改建等原因令排氣管出口位於室內，以避免引致一氧化碳中毒或火警危險。



重要安全指示



注意

有關安裝

- 嚴禁安裝爐具於室外地方。
- 爐具必須在空氣流通的房間安裝及使用。
- 不建議將爐具安裝在吊櫃或壁櫃內。
- 如爐具安裝在間隔室內，最小間隔室通風口需符合機電工程署〈工作守則：氣體應用指南之三〉內的要求。
- 請盡量縮短熱水喉管的長度，以及避免水管有可能導致閉塞及滯水的地方。
- 盡量縮短熱水出口與水龍頭的距離。
- 安裝排氣管時，確保排出的煙氣不會直接排向外牆、窗戶、玻璃、鋼門或鋁窗框等物件，這或會引致這些物件出現變形及變色。

排氣管出口

遵照下列指示，避免火警

- 切勿於爐具或排氣管周圍擺放易燃物品，如紙張、木材或衣服。
- 切勿於爐具或排氣管周圍擺放或使用揮發性油劑，如汽油或揮發油。
- 切勿於爐具或排氣管出口周圍擺放或使用噴霧罐，如噴髮劑或噴霧清潔劑。

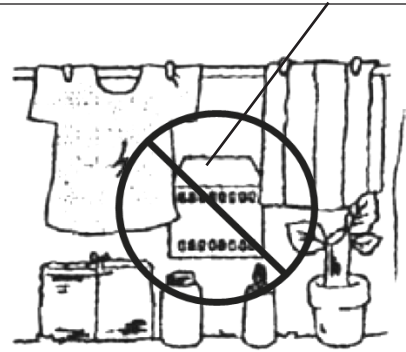

有關用途

- 本爐具只供家居用途。為免縮短爐具的壽命，請勿用於商業用途。
- 請勿將流經本爐具的水用作飲用或煮食用途。
- 本爐具只作供應熱水給浴室或廚房使用，切勿用作其他用途，以免發生意外或損壞爐具。

遵照下列指示以防燙傷

- 當使用熱水後，立即重開熱水水龍頭或迅速減慢熱水流出時，較高溫的熱水有機會突然噴出。為避免燙傷危險，切勿將熱水直接噴灑在頭和身體上。
- 當使用花灑時，較高溫的熱水可能會先流出。為避免燙傷，請先用手確認水溫。切勿直接將熱水噴灑在頭和身體上。



先用手確認水溫



切勿觸摸排氣管



- 爐具使用期間或使用後，切勿觸摸排氣管，避免燙傷。

重要安全指示



注意

有關爐具控制器



- 請勿讓小孩隨意按動爐具的面板控制器。避免造成意外或損毀爐具。



有關使用



- 若爐具已停用超過一星期，於使用前，應將滯留於水管內的水先排走。
- 進行排水時，請盡量避免產生水霧。使用延伸水管連接出水口及排水位。
- 排水方法：將距離爐具最遠的熱水水龍頭完全開啟1分鐘。

有關清潔及保養



- 若爐具或喉管接觸到含氯除菌劑、酸性浴室清潔劑、除臭劑或食鹽，請用大量的清水把它們沖掉，避免造成意外或損毀爐具。
- 切勿使用溶劑或油性清潔劑清潔爐具，否則或會令爐具變色或變形。
- 請使用原廠零件及配件，避免造成意外或損毀爐具。

產品介紹

RS68B

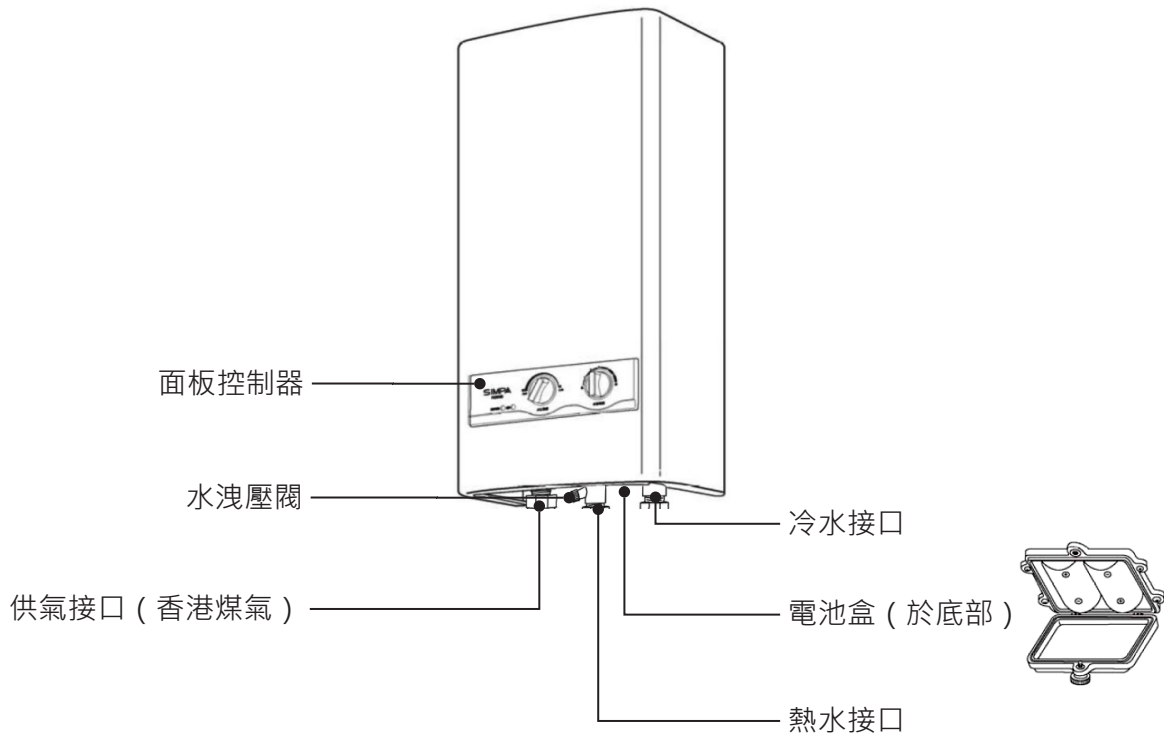

面板控制器

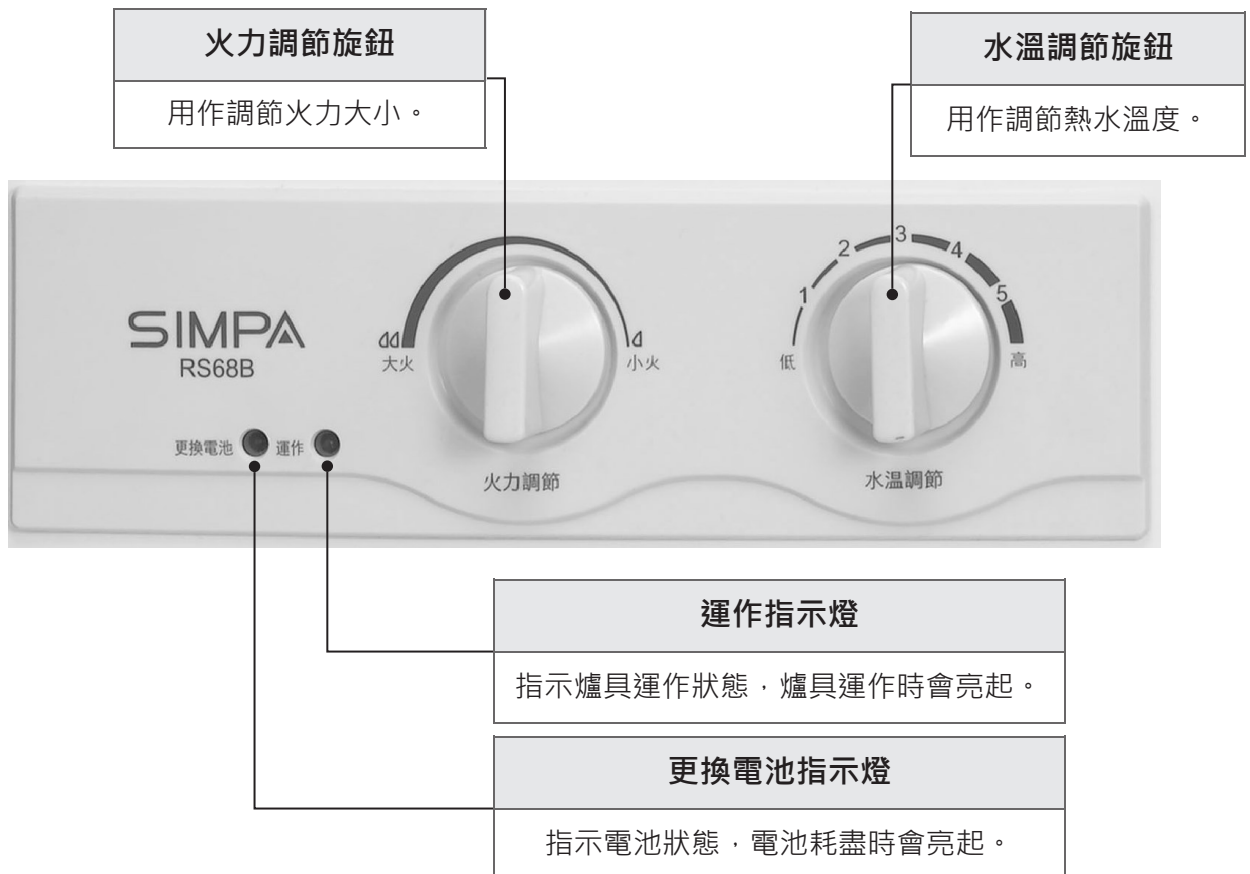

產品介紹

RS10B / RS10BV

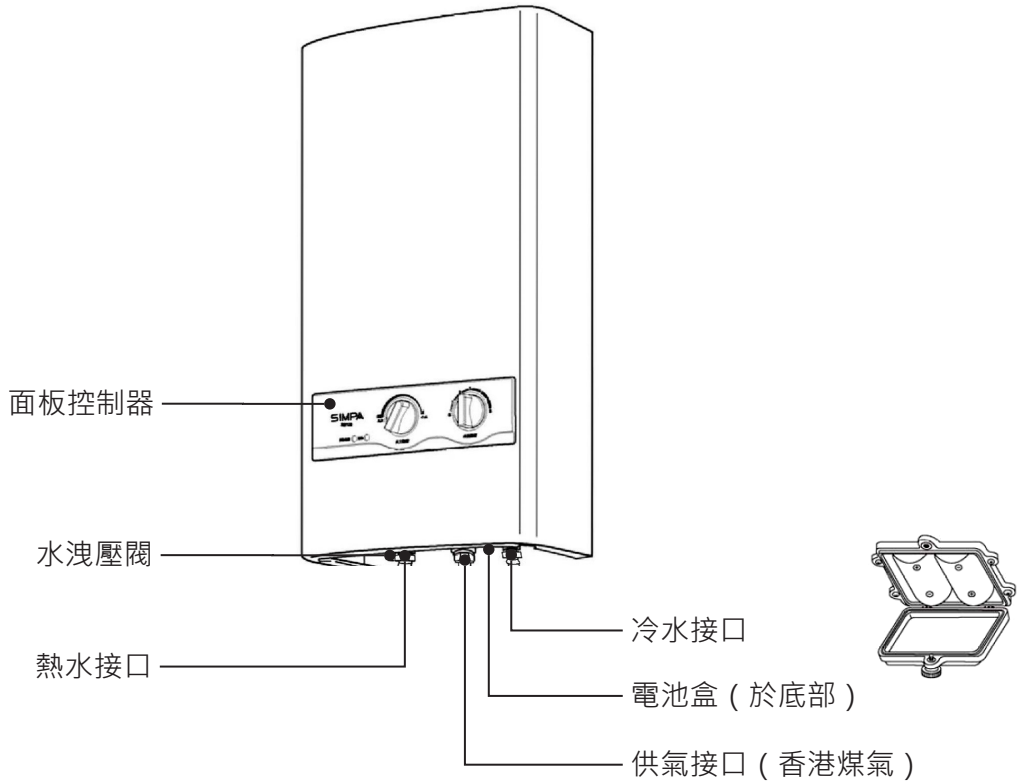

面板控制器

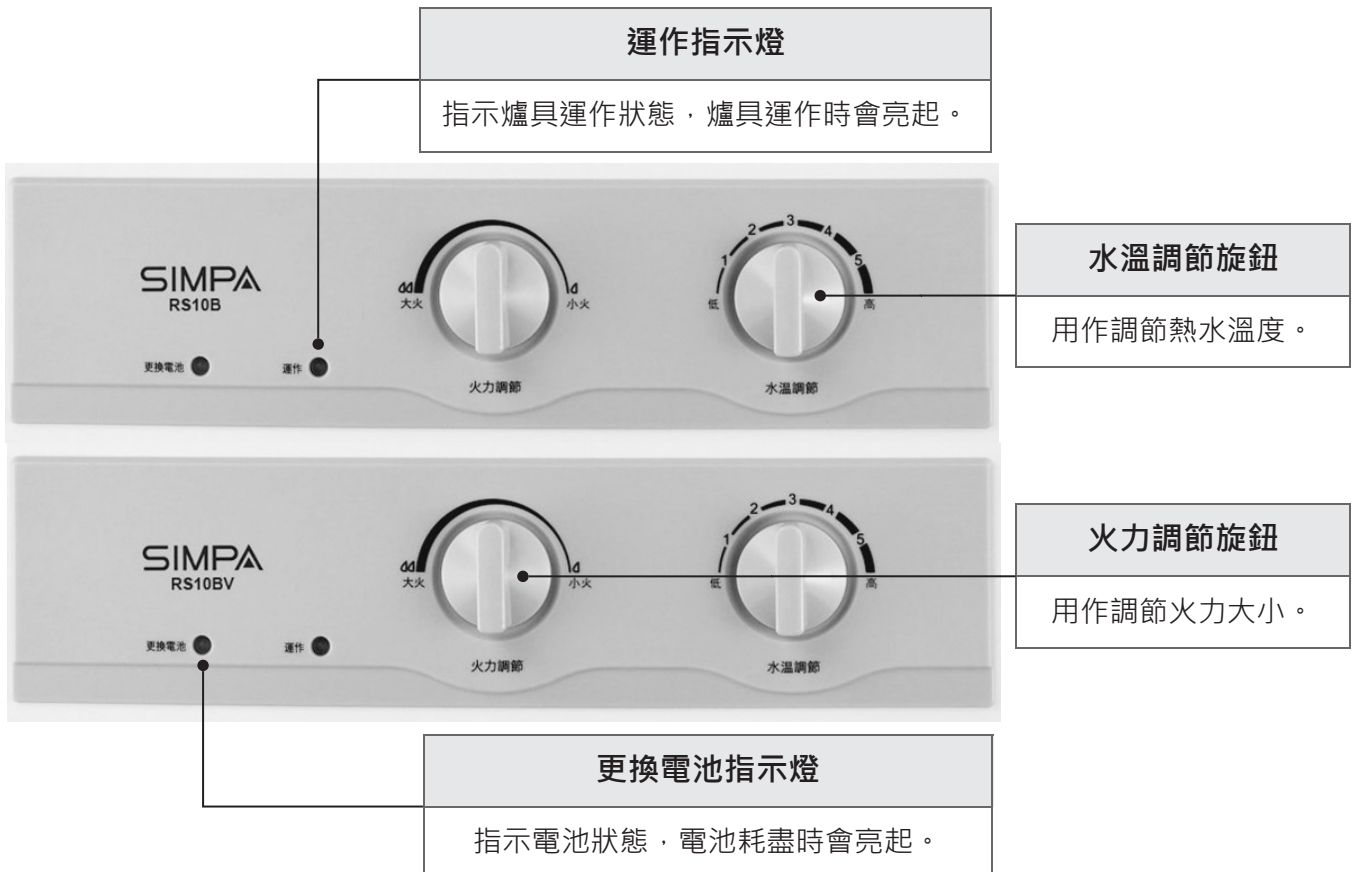

操作指示

注意

- 首次或於早上使用爐具時，供氣管道內有機會因殘留空氣而無法即時自動點燃燃燒器。請關閉熱水水龍頭，待 10 秒後再開啟熱水水龍頭，重複自動點燃程序。

- 為避免燙傷：



- 淋浴前請先用手確認水溫，切勿直接將熱水噴灑在頭和身體上。
- 使用高溫熱水後，水管中仍存有高溫熱水。再次使用熱水時，應先用手確認水溫，待溫度適合後才使用。



先用手確認水溫

- 在供水壓力較高的情況下，使用爐具時有機會出現較大的水流聲，此屬正常現象。
- 長時間不使用爐具時，請關閉冷水水掣及爐具供氣閥。

初次使用爐具

請按步驟 ❶ 至 ❺，檢查爐具運作。

- ❶ 開啟冷水水掣。

- ❷ 完全開啟熱水水龍頭，確認正常出水後關閉。

- ❸ 完全開啟爐具供氣閥。

- ❹ 裝上電池。

方法：電池盒位於機身下方，依照盒內標示的電池正、負極方向，正確裝上電池（1.5伏D型鹼性電池兩枚）。

- ❺ 分別將火力調節及水溫調節旋鈕轉至「小火」及「低」的旋鈕標示位置。完全開啟熱水水龍頭，並確認熱水流流出後關閉。

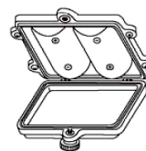
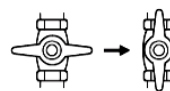
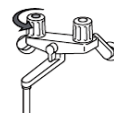
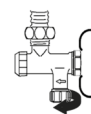

RS68B

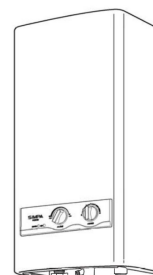

RS10B/RS10BV

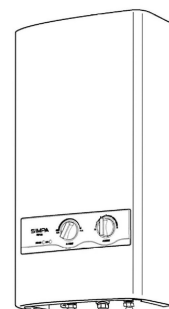

操作指示

使用爐具

(1) 啟動爐具

- 當完全開啟熱水水龍頭時，爐具立即運作。

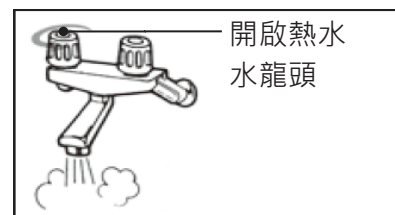

(2) 使用熱水

- 開啟熱水水龍頭後，燃燒器會自動點燃，熱水隨即流出。運作指示燈同時亮著。
- 熱水水龍頭不宜開啓過小，否則使用時有機會出現無法燃點或中途熄火現象。



(3) 調較熱水水溫

- 轉動水溫調節旋鈕及火力調節旋鈕可調較熱水水溫。

• 火力調節旋鈕：

轉動旋鈕以調節火力。於出水量維持不變的情況下，以逆時針方向轉動火力調節旋鈕可提高熱水水溫；以順時針方向轉動火力調節旋鈕則可降低熱水水溫。火力可調節範圍為小火-大火。旋鈕標示「小火」為最低火力，而旋鈕標示「大火」則為最高火力。



• 水溫調節旋鈕：

轉動旋鈕以調節水溫。以順時針方向轉動水溫調節旋鈕提高熱水水溫；以逆時針方向轉動火力調節旋鈕則降低熱水水溫。水溫可調節範圍為低-1-2-3-4-5-高。旋鈕標示「低」為最低水溫，而旋鈕標示「高」則為最高水溫。



(4) 停止使用熱水

- 關閉熱水水龍頭後，爐具立即停止運作，熱水停止流出。運作指示燈同時熄滅。
- 需再次使用熱水時，重複步驟 (1) 至 (3)。

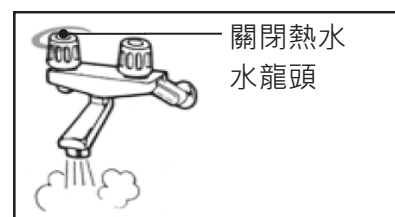

操作指示

更換電池

- 開啟熱水水龍頭後，爐具立即運作。如紅色電池指示燈連續閃爍，即表示電池處於低電量狀態。此狀態下，爐具仍可繼續運作，但須準備兩枚 1.5 伏 D 型鹼性電池於電量耗盡時作更換用途。
- 於電量耗盡時，爐具將無法點火，紅色電池指示燈會亮著。請檢查煤氣錶閥及爐具供氣閥是否完全開啟。確認後，重新開啟熱水水龍頭。如紅色電池指示燈仍然亮著，且無法點火，請更換電池。
- **更換電池：**
 - 電池盒位於爐具的底部位置。鬆開電池盒螺絲，並打開電池盒。依盒上所示將兩枚電池裝上。完成後，關閉電池盒並妥善鎖緊電池盒螺絲。錯誤裝配電池會導致爐具不能運作。
 - 請同時換上兩枚相同品牌的新電池。如所更換的電池為一新一舊或不同品牌，則有機會引致電池破裂或電池液洩漏等情況，並造成爐具損壞。

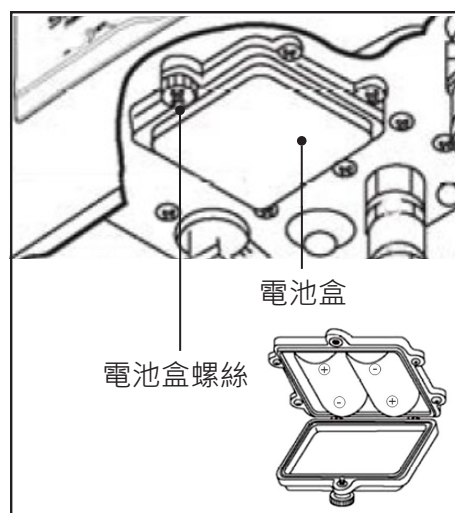

安全設施

- **熄火安全裝置：**裝置利用火焰感應棒監察燃燒狀態是否正常。當火焰失效時，火焰失效訊號會傳送到主控器以停止供氣。
- **殘火安全裝置：**熱水水龍頭關閉後，若火焰仍然存在而熱交換器內的熱水溫度高達 90°C 時，裝置會停止供氣。
- **防止過熱保護裝置：**當熱交換器燒毀或溫度高達 150°C 時，裝置會啟動，並停止爐具運作。
- **防止過高水壓裝置：**當爐具內的水壓高於 2100kPa，位置於熱水出口的水洩壓閥會打開洩壓，並於水壓降回 1700kPa 的水平後關閉。

調節熱水溫度提示

- RS68B 可提供每分鐘 6.8 公升流量（升溫 25°C）的熱水，而 RS10B / RS10BV 則可提供每分鐘 10 公升流量（升溫 25°C）的熱水。為配合在不同季節的沐浴使用，可透過面板控制器調節所需的熱水溫度。
- 在冬季偶有極寒冷的天氣，自來水的溫度可能過低或熱水流量過大，爐具的出水溫度可能會比較低，您可以調節水龍頭或花灑掣來減少熱水水流量，以便獲得適合的水溫。
- 在夏季偶有極炎熱的天氣，自來水的溫度可能過高或熱水流量過小，爐具的出水溫度可能會比較高，您可以調節水龍頭或花灑掣輔以混合冷水，以便獲得適合的水溫。

保養

- (1) 爐具機身不可用溶劑清潔，應使用濕軟布揩抹，再用乾軟布抹乾。
- (2) 如花灑出水量變少，花灑頭的水孔可能已堵塞。應檢查並加以清理。
- (3) 必須定期檢查及保養爐具，以確保使用上的安全及效率。

故障處理

故障	故障原因	處理方法
沒有點火或沒有熱水供應	仍未開啟煤氣錶閥及 / 或爐具供氣閥	完全開啟煤氣錶閥及 / 或爐具供氣閥。
	喉管內含有空氣	關閉熱水水龍頭，10秒後重新開啟熱水水龍。
	電量已耗盡	更換電池。
	供水壓過低	完全關閉冷水掣，並清洗冷水掣的濾水網。清洗後妥善裝回冷水掣及完全開啟熱水水龍頭。
	花灑出水孔阻塞	清理花灑。
	混合水龍頭的調節不當，冷水過多	減少混合水龍頭的冷水量。
熱水溫度過低	爐具供氣閥沒有完全開啟	完全開啟爐具供氣閥。
	水溫調節或火力調節旋鈕的設置不適當	適當地調較水溫或火力旋鈕。
熱水溫度過高	水溫調節或火力調節旋鈕的設置不適當	適當地調較水溫或火力旋鈕。
更換電池指示燈閃爍	電量過低	爐具仍可使用（應準備新電池）。
更換電池指示燈亮著	電量耗盡	更換電池。
運作指示燈熄滅	無法點火	關閉熱水水龍頭，並確認爐具供氣閥完全開啟。確認後，重新開啟熱水水龍頭。如故障仍然存在，請致電煤氣公司客戶服務熱線。
	中途熄火	

在一般情況下，關閉熱水水龍頭然後重新開啟，故障有可能消除。若故障仍然存在，請致電煤氣公司客戶服務熱 2880 6988。

在寒冷及潮濕的天氣，排煙管出口偶會冒出煙霧，這是煙氣中的水氣遇冷而形成白色煙霧，此屬正常現象。

規格

型號		RS68B	RS10B	RS10BV	
基本規格	爐具類別	自然排煙密封式			
	安裝方式	掛牆式			
	排氣方式	背排式			
	機身尺寸 - 闊 x 高 x 深 (毫米)	265 x 590 x 179.5	370 x 705 x 170		
	重量 (千克)	9.5	13.5		
	燃氣種類	香港煤氣			
	供氣壓力 (千帕)	1.5			
	接駁	燃氣	G3/4		
		冷水	G1/2		
		熱水	G1/2		
		電源	1.5伏 D型鹼性電池 (2枚)		
點火方式	自動電子點火				
額定熱負荷 (千瓦)	最高	14.8	22.1		
	最低	5.6	7.7		
系統運作	熱水供應量25°C升溫 (公升/分鐘)	6.8	10.0		
	熱水供應量範圍 (公升/分鐘)	3.0 至 6.8	3.5 至 10.0		
	最低熱水流量 (公升/分鐘)	3.0	3.5		
	最低運作水壓 (千帕)	30	25		
	正常運作水壓範圍 (千帕)	70 至 700			
安全裝置	熄火安全裝置	火焰感應棒			
	殘火安全保護裝置	雙金屬開關 (90°C)			
	防止過熱保護裝置	溫度保險絲 (150°C)			
	防止過高水壓保護裝置	水洩壓閥 (啟動: 2100 千帕)			

Contents



Important Safety Instructions	P. 1
Product Descriptions	P. 5
Operating Instructions	P. 7
Maintenance	P. 10
Trouble Shooting	P. 10
Specifications	P. 11

Attention!

According to the Gas Safety Ordinance of Hong Kong, any gas installation works including the installation of appliances and connection tubing, must be undertaken by registered gas installers who are registered for that appropriate classes and be employed by registered gas contractors.

Important Safety Instructions

In order to use this appliance safely, please be sure to follow the below guidelines. The following guidelines have an important bearing on safety. Symbols and their meanings are as below.

 Danger	If you ignore this symbol and mistakenly handle the appliance, it may incur death, or serious injury and will lead to an imminent danger of
 Warning	If you ignore this symbol and mistakenly handle the appliance, it may incur death, or serious injury and will lead to a possibility of fire
 Caution	If you ignore this symbol and mistakenly handle the appliance, this may incur injury or property damage.

The above injuries and properties damage refer specifically to the following descriptions.

- Injury: injuries, burns and electric shocks etc. that require treatment in hospital or long-term hospitalization.
- Properties Damage: widespread damage to house and furnishings.

In this user instructions includes different symbols, please refer to the following descriptions for the meanings of corresponding symbols.



Danger



If you notice following problems with this appliance



- If you notice abnormal flames, gas smell or strange sounds when using the appliance, please turn off hot water tap and gas meter valve immediately and contact the Towngas company.
- In the event of earthquake or fire, cease operation without hesitation.



1. Turn off hot water tap

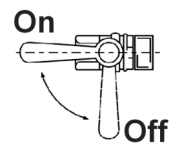

2. Turn off gas meter valve



Do not place the outlet of flue terminal indoor

- The outlet of flue terminal should be faced outdoor.



Important Safety Instructions

Danger



If you notice a gas leak

1. Cease use and close the gas meter valve.

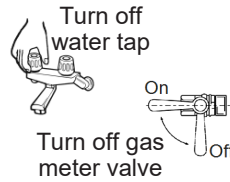

2. Open all windows to disperse the gas.



3. Call Towngas Emergency Hotline on 2880 6999 with a phone outside the premises.



If there is a gas leak

- Do not ignite a fire, insert or remove power plug.
- Turn on or off any electrical appliance is forbidden.
- Do not use nearby telephone or mobile phone.



When there is a gas leak, do not perform any of the above actions until repair work has been completed.

Do not perform any of the above actions and turn on the gas meter valve again until the gas is no longer leaking.

Warning

Care to be taken with children



- When filling hot water into the bath-tub, do not allow children to play in the bathroom to avoid the children falling into the bath-tub or causing any dangers.
- Do not allow children to bath without the supervision of adult.

Self disassembling, repairing and modification of appliance are strictly forbidden



- Gas installer, who performs any installation, maintenance and its related work of appliance, shall be employed by registered gas contractors and be registered under appropriate class of gas installation work to prevent hazard or damage of appliance.

Do not cover outlet of flue terminal



- Do not place the outlet of flue terminal in an indoor environment due to additions or reconstruction in order to avoid the occurrence of carbon monoxide poisoning or fire hazard.



Important Safety Instructions

Caution

Regarding installation



- Do not install the appliance at outdoor.
- Install and use the gas appliance in a well-ventilated room.
- It is not recommended to install the gas appliance inside any hanging wall case or cupboard.
- If the gas appliance is installed in compartment, the minimum compartment ventilation should follow the requirements in Code of Practice GU03 from EMSD.
- Minimize pipe length and avoid dead legs and stagnant corners in hot water pipework.
- Minimize the distance between hot water outlet and water tap.
- When installing the flue terminal, make sure the flue gas does not discharge directly to the outside walls, windows, glass, mesh doors or aluminum sashes etc. This could cause material disfiguration or discolouration.

What you must do to prevent fire



- Do not place things that easily burn, such as paper wood or clothes, around the appliance or flue terminal.
- Do not place or use flammable materials, such as gasoline or benzine, around the appliance or flue terminal.
- Do not place or use spray cans, such as hair spray or spray cleaners, around the appliance or flue terminal.

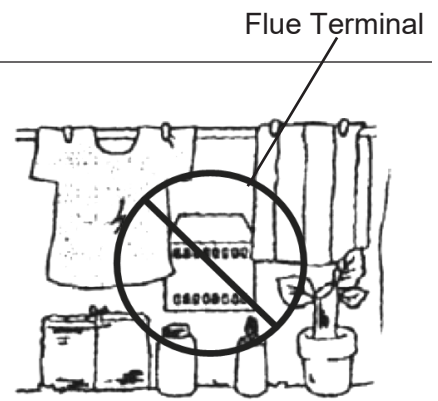

Regarding use



- This appliance is intended for residential application only. Do not use it for commercial application lest its service life is shortened.
- Do not use water from the appliance for drinking or cooking.
- This appliance is intended for supplying hot water to bathroom and kitchen. Do not use it for other purpose in order to avoid incident or damage of appliance.

What you must do to prevent scalding



- When opening the tap again after using hot water, or quickly reduce the hot water flow, relatively high-temperature hot water may suddenly come out. As there is a risk of being scalded, do not direct the hot water onto your head or body.
- When using the shower, relatively high-temperature hot water may come out first. In order to prevent scalding, check the water temperature with hand first. Do not direct the hot water onto the head or body.



Check water temperature with hand first



- During and immediately after using the appliance, do not touch the flue terminal to prevent from scalding.



Do not touch flue terminal

Important Safety Instructions

Caution

Regarding control usage



- Keep the front panel control out of reach of children. It is intended to prevent accidents or damage of appliance.



Regarding operation



- If appliance is not used for more than one week, drain away stagnant water inside the water pipework before use.
- During water purging, avoid generation of water mist. Use extension pipe to connect water outlet and drain point.
- Method of water purging: Fully turn on the most distant hot water tap from the appliance for 1 minute.

Regarding cleaning and maintenance



- If the appliance or pipework circuits are in contact with chlorine-based fungicides, acidic bathroom cleaners, deodorants or salt, wash them off with ample water straight away to prevent causing accidents or damage.
- Do not use solvent or oil-based cleaners to clean the appliance. This could cause discolouration or disfiguration of appliance.
- Use only genuine parts for this appliance to prevent causing accidents or damage of appliance.

Product Descriptions

RS68B

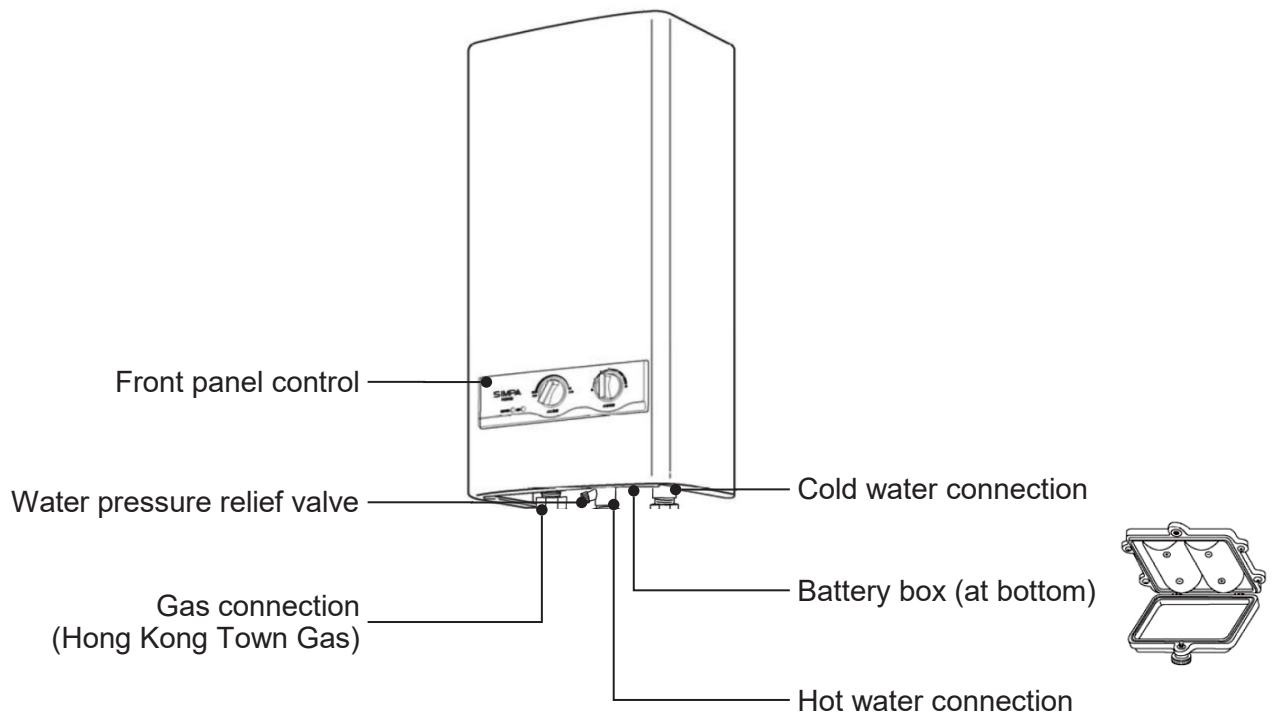

Front Panel Control

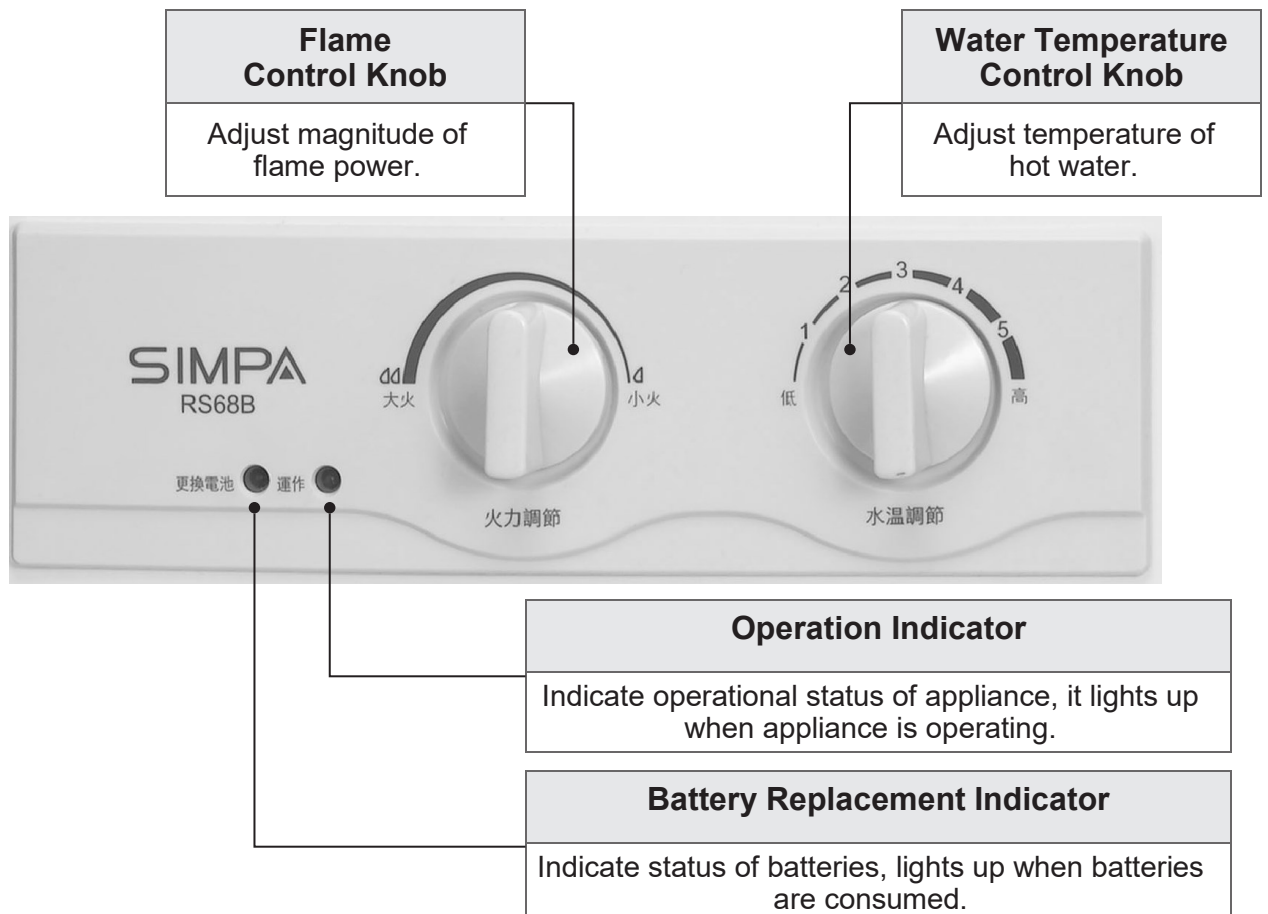

Product Descriptions

RS10B / RS10BV

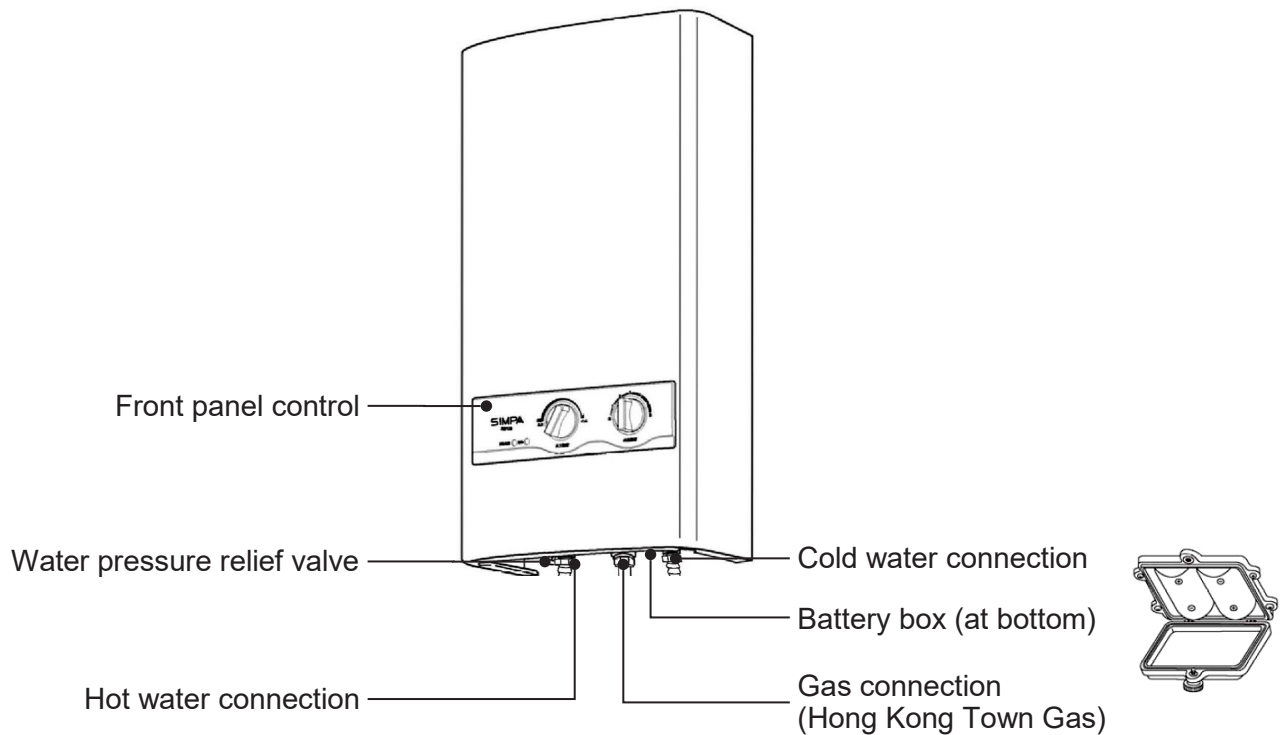

Front Panel Control

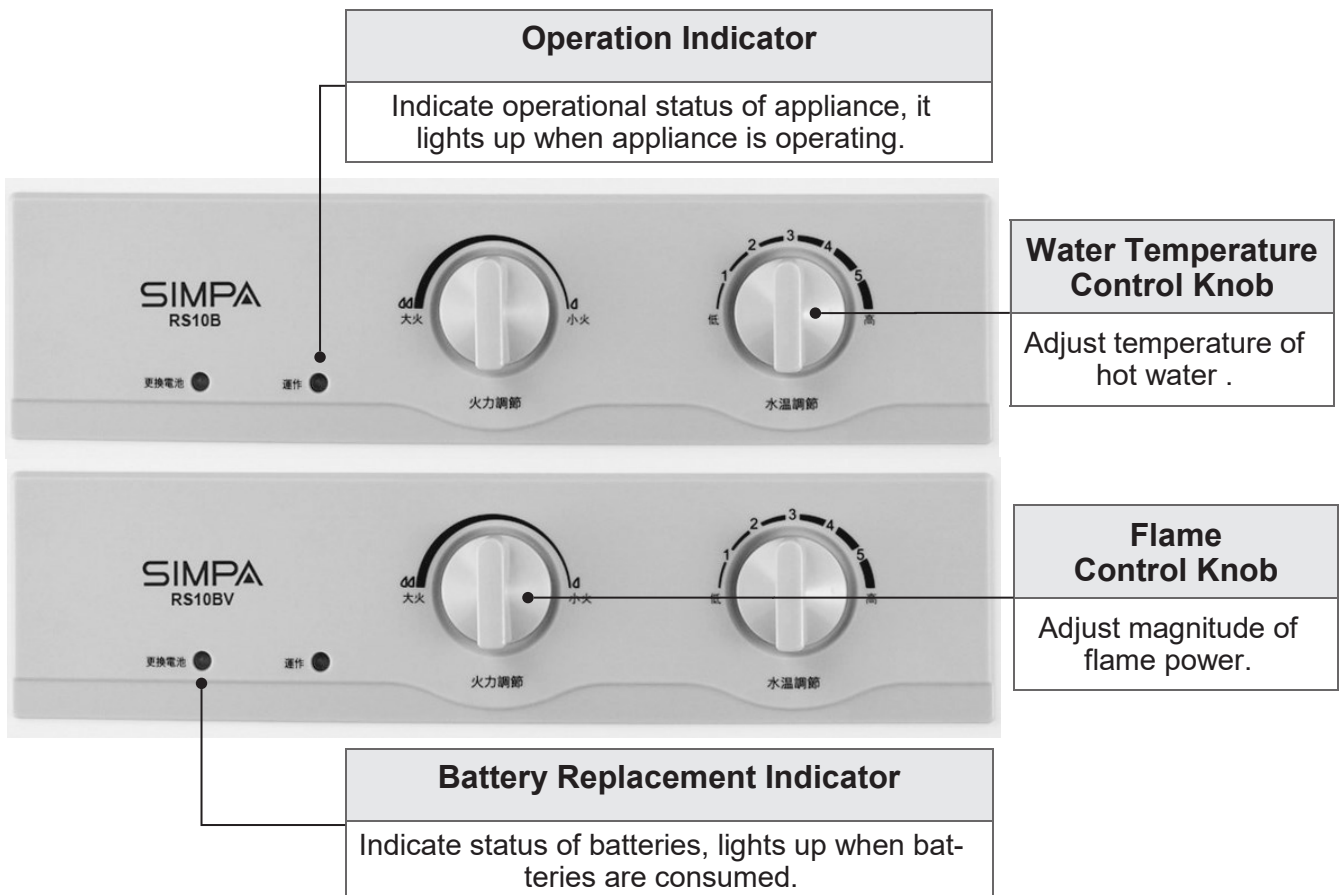

Operating Instructions

Caution



- When using the appliance for the first time or in the morning, the burner may not be ignited instantly because there may be some air remained inside the gas pipe. Please turn off the hot water tap and wait for 10 seconds, then turn on the hot water tap again to repeat the auto-ignition process.
- To prevent scalding:
 - check water temperature with hand first before taking shower. Do not direct hot water onto the head or body directly.
 - After using high-temperature hot water, the high-temperature hot water still remains inside the water pipework. To use hot water again, check the temperature with hand first and wait for suitable temperature before use.
- In case of high water supply pressure, relatively loud sound of water flow may occur during the operation of appliance. This is a normal phenomenon.
- Turn off the cold water valve and the gas supply valve of appliance when it is not used for a long period of time.



Check water temperature with hand first

First Time Usage of Appliance

Check the appliance by following step ① to ⑤.

- ① Fully turn on the cold water supply valve.

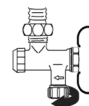

- ② Turn on the hot water tap, and check if water is running and close tap.

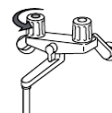

- ③ Fully open the gas valve.

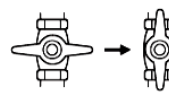

- ④ Insert the batteries.
Method: Battery box is located at the bottom of appliance body. Follow the icons of positive and negative terminals direction inside the box to insert the batteries (2 pieces of 1.5V D-size alkaline batteries).

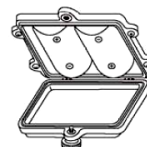

- ⑤ Set the flame control and water temperature control knobs at the knob icon location with “Small Flame (小火)” and “Low (低)” respectively. Fully turn on the hot water tap and turn off after confirming the hot water is running out.



RS68B

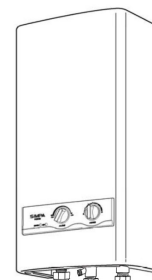

RS10B/RS10BV

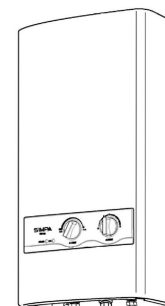

Operating Instructions

Use of Appliance

(1) Starting use of appliance

- Appliance operates immediately when the hot water tap is fully turned on.

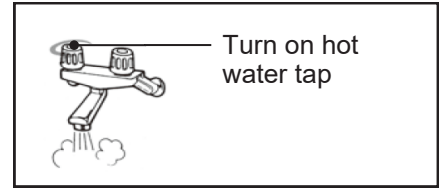

(2) Using hot water

- After turning on hot water tap, burner will be ignited automatically and hot water will be supplied. Operation indicator lights up simultaneously.
- Hot water tap should not be turned on insufficiently. Otherwise, ignition may fail or the flame may extinguish during use.

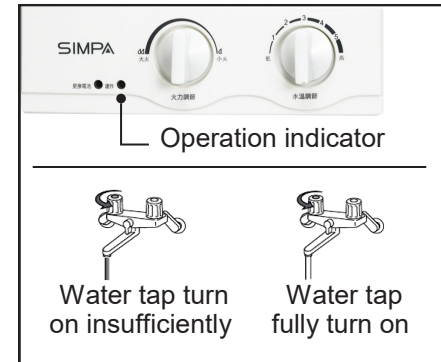

(3) Adjusting temperature of hot water

- Temperature of hot water can be adjusted by flame control knob and water temperature control knob.

• Flame control knob

Turn the knob to adjust flame power. With the output water volume unchanged, turning the knob in anti-clockwise direction to increase hot water temperature; while turning the knob in clockwise direction to decrease hot water temperature. Range of adjustment of flame power is **Small Flame(小火)-Large Flame(大火)**. Icon beside the knob with “**Small Flame(小火)**” is the lowest flame power. Icon beside the knob with “**Large Flame(大火)**” is the highest flame power.

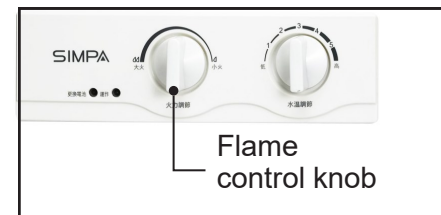

• Water temperature control knob

Turn the knob to adjust water temperature. Turning the knob in clockwise direction to increase hot water temperature; while turning the knob in anti-clockwise direction to decrease hot water temperature. Range of adjustment of water temperature is **Low(低)-1-2-3-4-5-High(高)**. Icon beside the knob with “**Low(低)**” is the lowest water temperature. Icon beside the knob with “**High**” is the highest water temperature.



(4) Stopping use of hot water

- Appliance stops operation immediately and hot water will stop supplying when the hot water tap is turned off. Operation indicator goes out simultaneously.
- To use hot water again, repeat step (1) to (3).

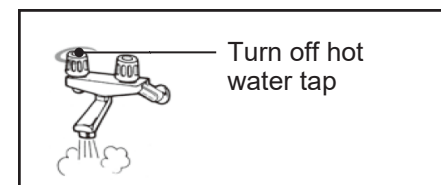

Operating Instructions

Change of Battery

- Appliance operates immediately when hot water tap is turned on. If the red battery replacement indicator is flashing, it means the batteries have reached a low battery level. At this status, appliance can still be operated. Please prepare two pieces of D-sized 1.5V alkaline battery for replacement once the batteries are consumed.
- When the batteries are consumed, appliance cannot be ignited with the red indicator lights up. Check whether the gas meter valve and gas supply valve of appliance are fully turned on. After confirmation, turn on the hot water tap again. If the red indicator still lights up and it has no ignition, please replace the batteries.
- **Replacing battery:**
 - Battery box is located at the bottom of appliance. Loosen the battery box screw and open the battery box. Follow indications to fix two pieces of battery. Tighten the screw properly and close the battery box after replacement. Appliance cannot be operated due to incorrect fixing of batteries.
 - Please replace the two pieces of new battery with same brand. If the batteries to be replaced are mixed with old and new ones or with different brands, there will be risk of battery crack or leak conditions and causing damage on appliance.

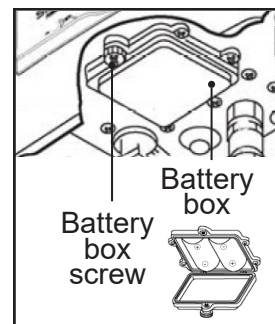
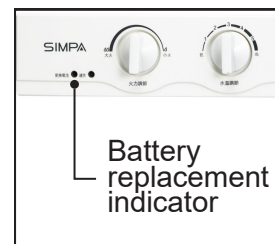

Safety Device

- **Flame failure device:** Using the flame rod sensor to monitor whether the combustion status is normal. When the flame fails, flame failure signal will be sent to the main controller to stop gas supply.
- **Remaining flame safety device:** If the flame still remains with the hot water temperature inside the heat exchanger has reached 90°C after the hot water tap has been turned off, the device will stop the gas supply.
- **Over heat protection device:** If the heat exchanger burns out or the temperature reaches 150°C, the device will activate and stop the operation of appliance.
- **Over pressure protection device:** If the water pressure inside the appliance is over 2100kPa, the pressure relief valve located near the hot water outlet will be opened to release pressure. After reducing to 1700kPa, it will then be closed.

Reminder of Adjusting Hot Water Temperature

- **RS68B** is capable to deliver a flow rate of 6.8L/min (at 25°C temperature rise) hot water, while **RS10B / RS10BV** is capable to deliver a flow rate of 10L/min (at 25°C temperature rise) hot water. To suit bathing purpose of different seasons, you may adjust hot water temperature through front panel control.
- In winter, there may be occasional extremely cold weather where supply water temperature is exceptionally low or required water flow is too high, hot water temperature of appliance may be relatively less. You may appropriately reduce the hot water flow by adjusting water faucet or shower tap to attain the suitable water temperature.
- In summer, there may be occasional extremely hot weather where supply water temperature is exceptionally high or required water flow is too low, hot water temperature of appliance may be relatively higher. You may adjust water faucet or shower tap to mix with cold water for attaining suitable water temperature.

Maintenance

- (1) Never use solvents to clean the body of appliance. Please wipe the surface with a soft damp cloth, then dry with a soft cloth.
- (2) If the water flow at shower head is reduced, the holes of shower head may be blocked. It should be checked and cleaned.
- (3) It is necessary for the appliance to be inspected and maintained regularly so that it can be used safely and efficiently.

Trouble Shooting

Fault	Reasons of Failure	Remedy
No ignition or no hot water supplied	Gas meter valve and/or gas supply valve of appliance is turned off.	Fully turn on the gas meter valve and/or gas supply valve of appliance .
	Air is trapped inside gas pipe.	Turn off hot water tap, and wait for 10 seconds. Turn on hot water tap again.
	Batteries are consumed.	Replace the batteries.
	Water supply pressure is too low.	Turn off the cold water valve, and clean the filter. Fully turn on the cold water valve, and turn on the hot water tap.
	Holes of shower head are blocked.	Clean the shower head.
	Inappropriate adjustment of mixing-type faucet with too much cold water.	Reduce cold water flow of mixing-type faucet.
Hot water temperature is too low	Gas supply valve of appliance is not fully turned on.	Fully turn on gas supply valve of appliance.
	Inappropriate flame control or water temperature control knobs settings.	Adjust flame control and water temperature control knobs properly.
Hot water temperature is too high	Inappropriate flame control or water temperature control knobs settings.	Adjust flame control and water temperature control knobs properly.
Battery replacement indicator flashes	Low battery level.	Appliance can still be operated (should prepare new batteries).
Battery replacement indicator lights up	Batteries are consumed.	Replace the batteries.
Operation indicator goes off	Ignition failure.	Turn off hot water tap, confirm if gas supply valve of appliance is fully turned on. Turn on hot water tap again after confirmation. If error still persists, contact Towngas Customer Service Hotline.
	Flame failure during usage.	

In general cases, fault may be eliminated by turning off and then turning on the hot water tap again. If the fault still persists, please contact Towngas Customer Service Hotline on 2880 6988.

In cold and humid weather, cloudy mist may occasionally emerge from the flue terminal. The white mist is the condensate of water vapour in flue gases. This is a normal phenomenon.

Specifications

Model		RS68B	RS10B	RS10BV	
Basic Specifications	Appliance Type	Natural Draught Room-sealed Type			
	Installation Type	Wall-mount Type			
	Flue Type	Back Flued Type			
	Dimension - W x H x D (mm)	265 x 590 x 179.5	370 x 705 x 170		
	Weight (kg)	9.5	13.5		
	Gas Type	Hong Kong Town Gas			
	Gas Supply Pressure (kPa)	1.5			
	Connections	Gas	G3/4		
		Cold Water	G1/2		
		Hot Water	G1/2		
		Power Supply	1.5V D-sized Alkaline Battery (2 pieces)		
Ignition Type	Automatic Spark Ignition				
Rated Heat Input (kW)	Maximum	14.8	22.1		
	Minimum	5.6	7.7		
Operation System	Amount of Hot Water Supply with 25°C Temperature Rise (L/min)	6.8	10.0		
	Amount of Hot Water Supply Range (L/min)	3.0 to 6.8	3.5 to 10.0		
	Minimum Hot Water Flow (L/min)	3.0	3.5		
	Minimum Operation Water Pressure (kPa)	30	25		
	Range of Normal Operation Water Pressure (kPa)	70 to 700			
Safety Devices	Flame Failure Device	Flame Rod Sensor			
	Remaining Flame Protection Device	Bi-metal Switch (90°C)			
	Overheat Protection Device	Thermal Fuse (150°C)			
	Over Pressure Protection Device	Water Pressure Relief Valve (ON: 2100kPa)			



香港中華煤氣有限公司
The Hong Kong and China Gas Company Limited