

SIMPA

即熱式恆溫氣體熱水爐
Instantaneous Modulation Gas Water Heater

使用說明書
User Instructions

型號 Model
RS11TM / RS11RM

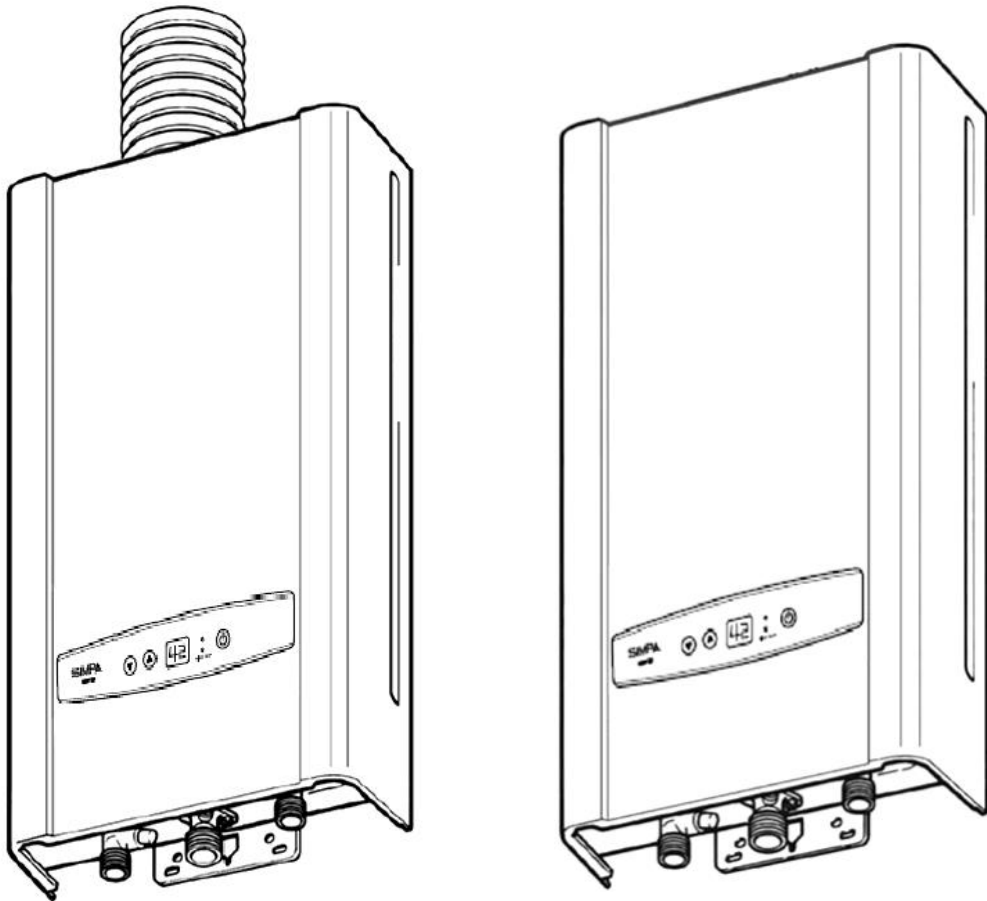

香港煤氣適用
For Hong Kong Town Gas

目錄



重要安全指示	第 1 頁
產品介紹	第 5 頁
操作指示	第 6 頁
保養	第 8 頁
故障處理	第 9 頁
規格	第 12 頁

注意!

根據香港氣體安全條例，任何氣體裝置工程，包括爐具和接駁喉管的安裝，必須由註冊氣體裝置技工執行，而該技工已於相關的氣體工程類別註冊及受聘於註冊氣體工程承辦商。

重要安全指示

為安全使用本爐具，請遵照下列各項指示。下列指示對安全有莫大關係，警示及其意思如下：

 危險	若忽視此警示，並作出錯誤行動，可能引致死亡或嚴重受傷和發生火警的危險。
 警告	若忽視此警示，並錯誤使用爐具，可能引致死亡或嚴重受傷，亦可導致
 注意	若忽視此警示，並錯誤使用爐具，可能會引致受傷和財物損毀。

上述描述所導致的受傷及財物損毀情況，請參考下列詳細描述。

- 受傷：出現損傷、燙傷及觸電等情況，並須送院治理或長期留院治療。
- 財物損毀：對房屋及傢俱等物件造成廣泛損毀。

本說明書中包含不同警示，請參考下列有關警示意思的描述。



危險、警告、
注意



禁止



切勿觸摸



必須執行



切勿拆開



必須接到地線



危險

若發現本爐具出現以下問題



- 當使用爐具時，若發現異常的火焰、氣味或特別的聲音，請立即關閉熱水水龍頭及煤氣錶掣，並通知煤氣公司安排檢修。
- 在發生地震或火災時，請立即停止操作爐具。



1. 關閉熱水水龍頭

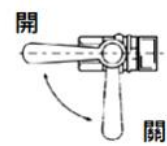

2. 關閉煤氣錶掣



切勿將煙道的出口置於室內

- 煙道的出口必須面向室外地方。



重要安全指示

⚠ 危險



若你發覺有煤氣洩漏

1. 請停止使用本爐具，並關閉煤氣錶掣。

2. 開啟所有窗戶讓煤氣排出屋外。

3. 使用位於室外的電話與煤氣公司緊急事故熱線 2880 6999 聯絡。



若發生燃氣洩漏



- 切勿點燃明火、插拔電源插頭。
- 禁止開啟或關閉電器產品。
- 切勿在附近使用電話、手機。



切勿在漏氣處理完畢前進行上述活動或再次打開煤氣錶掣。

⚠ 警告

請小心看管兒童



- 注入熱水到浴缸時，切勿讓兒童在浴室玩耍，以免兒童不小心掉進浴缸或導致預計不到的意外發生。
- 切勿讓兒童於沒有成人監督下洗澡。



嚴禁自行拆卸、維修或改裝爐具

- 爐具的安裝、維修及其他附帶工程，必須由受僱於註冊氣體工程承辦商及領有適當類別的氣體裝置技工進行，以免造成危險或損毀爐具。



切勿遮蓋煙道出口

- 請勿因增建或改建等原因令煙道出口位於室內，以避免引致一氧化碳中毒或火警危險。

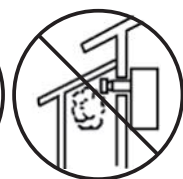
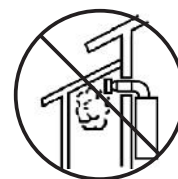

重要安全指示



注意

有關安裝



- 嚴禁安裝爐具於室外地方。
- 請儘量縮短熱水喉管的長度，以及避免水管有可能導致閉塞及滯水的地方。
- 儘量縮短熱水出口與水龍頭的距離。
- 安裝煙道時，確保排出的煙氣不會直接排向外牆、窗戶、玻璃、鋼門或鋁窗框等物件，這或會引致這些物件出現變形及變色。

遵照下列指示，避免火警



- 切勿於爐具或煙道周圍擺放易燃物品，如紙張、木材或衣服。
- 切勿於爐具或煙道周圍擺放或使用揮發性物品，如汽油或揮發油。
- 切勿於爐具或煙道周圍擺放或使用噴霧罐，如噴髮劑或噴霧清潔劑。

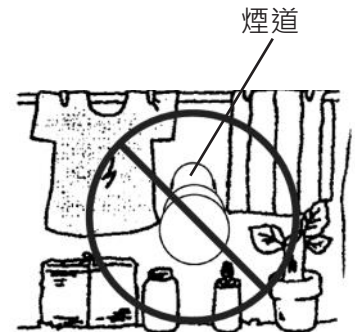

有關用途



- 本爐具只供家居用途。為免縮短爐具的壽命，請勿用於商業用途。
- 請勿將流經本爐具的水用作飲用或煮食用途。
- 本爐具只作供應熱水給浴室或廚房使用，切勿用作其他用途，以免發生意外或損壞爐具。

遵照下列指示以防燙傷



- 當使用熱水後，立即重開熱水水龍頭或迅速減慢熱水流出時，較高溫的熱水有機會突然噴出。為避免燙傷危險，切勿將熱水直接噴灑在頭和身體上。
- 當使用花灑時，較高溫的熱水可能會先流出。為避免燙傷，請先用手確認水溫。切勿直接將熱水噴灑在頭和身體上。



先用手確認水溫



- 切勿觸摸煙道，避免燙傷。



切勿觸摸煙道

重要安全指示



有關爐具控制器



- 請勿讓小孩隨意按動爐具的面板控制器或遙控器（如適用）。避免造成意外或損毀爐具。

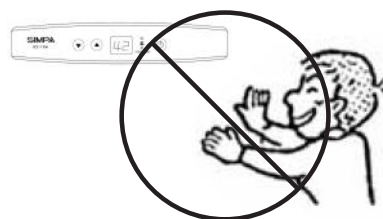

有關使用



- 若爐具已停用超過一星期，於使用前，應將滯留於水管內的水先排走。
- 進行排水時，應儘量避免產生水霧或水花。
- 排水方法：關閉爐具，將距離爐具最遠的熱水水龍頭完全開啟1分鐘。
- 為節省能源，不使用熱水時，應將爐具完全關閉。

有關清潔及保養



- 若爐具或喉管接觸到含氯除菌劑、酸性浴室清潔劑、除臭劑或食鹽，請用大量的清水把它們沖掉，避免造成意外或損毀爐具。
- 切勿使用溶劑或油性清潔劑清潔爐具，否則或會令爐具變色或變形。
- 請使用原廠零件及配件，避免造成意外或損毀爐具。

產品介紹

RS11TM / RS11RM

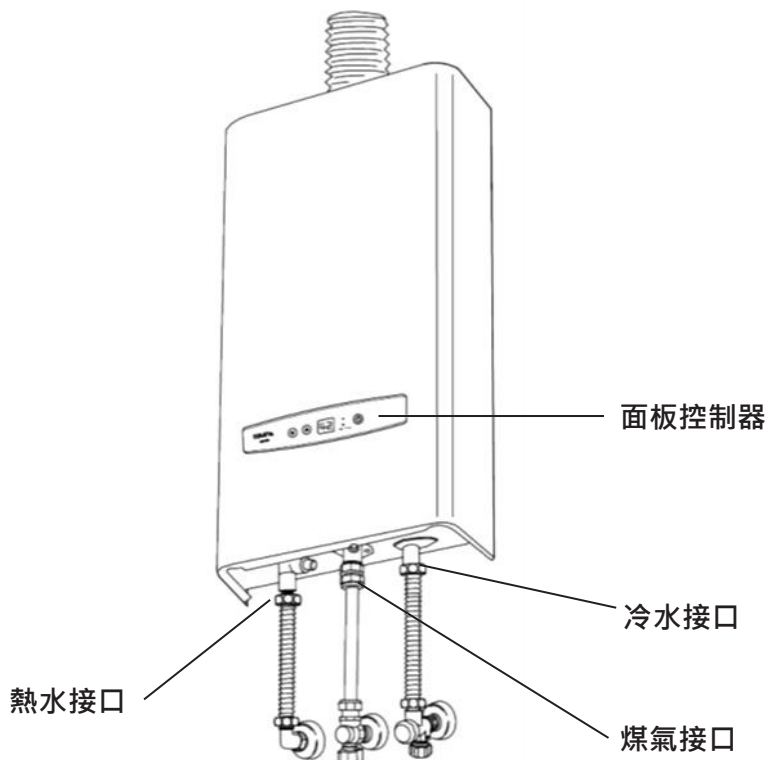

面板控制器

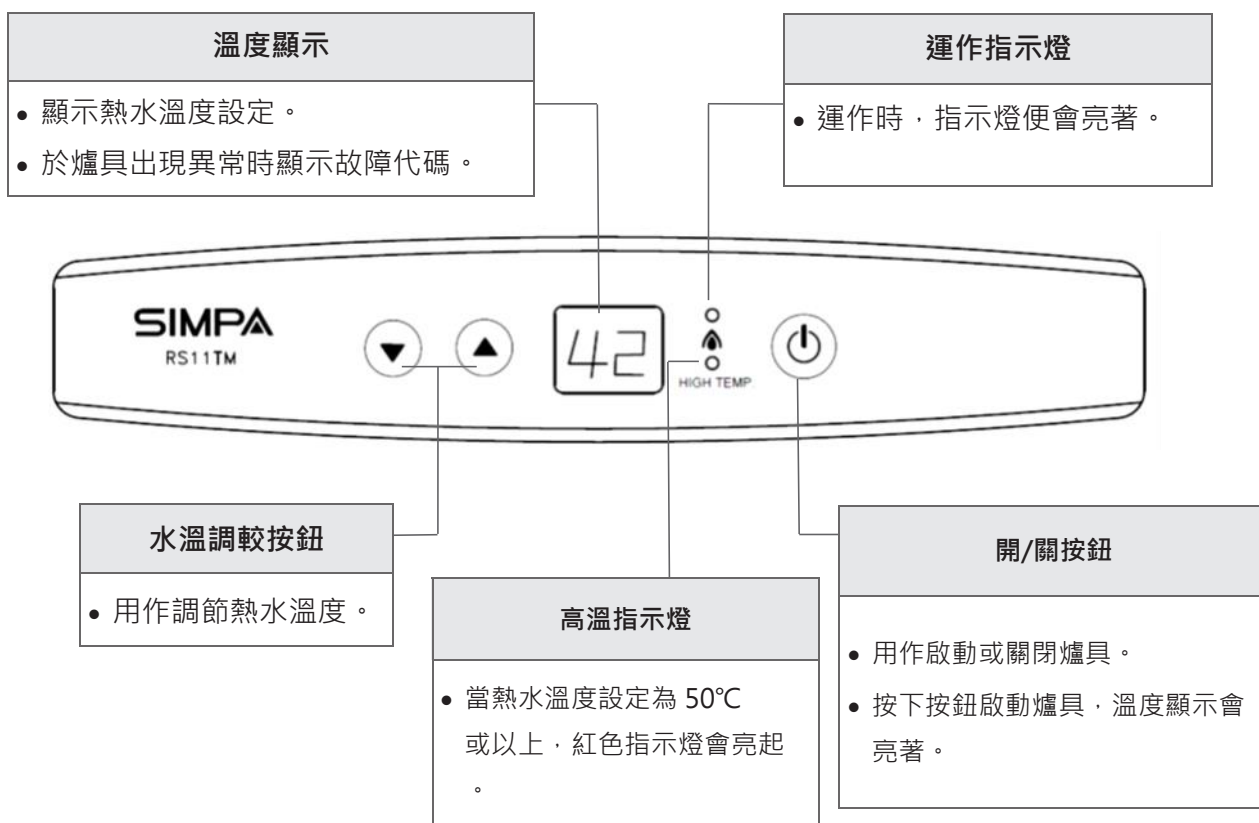

操作指示

注意

- 首次或於早上使用爐具時，供氣管道內有機會因殘留空氣而無法即時點燃燃燒器。請關閉熱水水龍頭，待 10 秒後再開啟熱水水龍頭，重複自動點燃程序。

- 為避免燙傷：

- 淋浴前請先用手確認水溫，切勿直接將熱水噴灑在頭和身體上。
- 使用高溫熱水後，水管中仍存有高溫熱水。再次使用較低溫的熱水時，應先用手確認水溫，待溫度適合後才使用。



先用手確認水溫

- 熱水水溫設定為 50°C或以上時，溫度顯示器會閃爍。請小心使用高溫熱水。
- 在供水壓力較高的情況下，使用爐具時有機會出現較大的水流聲，此屬正常現象。
- 長時間不使用爐具時，請關閉冷水水掣及爐具供氣閥。

初次使用爐具

請按以下指示檢查爐具運作。

- 將熱水水溫調節至 35°C的設定。完全開啟熱水水龍頭，並確認熱水流出後關閉。

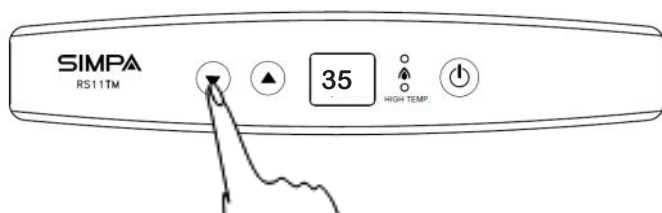

RS11TM

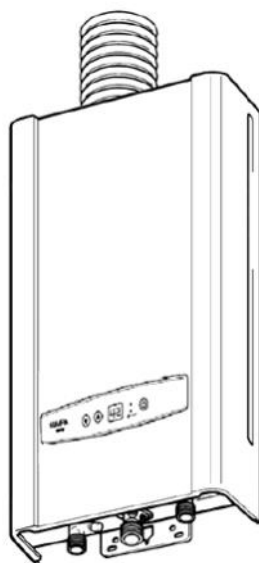

RS11RM

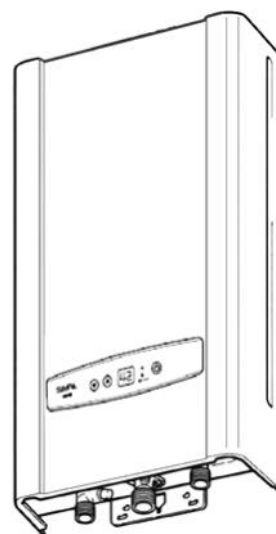

操作指示

使用爐具

(1) 啟動爐具

- 啟動爐具電源後，按面板控制器或遙控器（如適用）上的開/關按鈕。
- 溫度顯示亮起，此時爐具處於備用狀態。
- 安裝後首次使用時，預設溫度為 42°C。

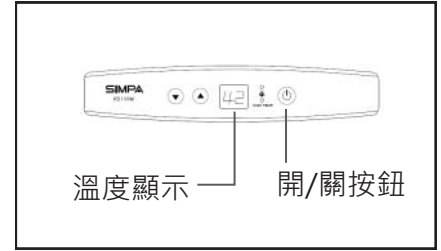

(2) 設定熱水水溫

- 按水溫調節按鈕調節熱水水溫。

調高熱水水溫	調低熱水水溫
最高水溫設定：55°C	最低水溫設定：35°C
熱水水溫可調節範圍	
35 37 38 39 40 41 42 43 44 45 46 47 48 50 55	

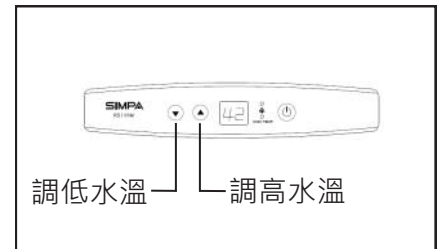

- 熱水溫度設定為 50°C 或以上時，高溫指示燈會亮起。

(3) 使用熱水

- 開啟熱水水龍頭後，燃燒器會自動點燃，熱水隨即流出。運作指示燈會亮起。
- 熱水流量低於最低熱水流量時，燃燒器便會關閉。因此熱水水龍頭不宜開啓過小，否則使用時有機會出現無法燃點或中途熄火現象。
- 爐具運作時，熱水溫度只可設定為 48°C 或以下。如熱水溫度已設定為 50°C 或以上，熱水溫度只可調低。



(4) 停止使用熱水

- 關閉熱水水龍頭後，爐具立即停止運作，熱水停止流出。運作指示燈會熄掉。
- 需再次使用熱水時，重複步驟（1）至（3）。
- 按面板控制器或遙控器（如適用）上的開/關按鈕，溫度顯示及運作指示燈會熄滅。

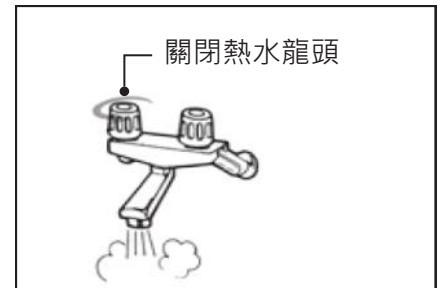

操作指示

安全裝置

- **熄火安全裝置**：裝置利用火焰感應棒監察燃燒狀態是否正常。當火焰失效時，信號會傳送到主控器以停止供氣。
- **殘火保護裝置**：熱水水龍頭關閉後，若火焰仍然存在而熱交換器內的熱水溫度高達設計溫度時，裝置會停止供氣。
- **防止過度沸騰保護裝置**：當熱水溫度高於設計溫度時，裝置會啟動，並停止爐具運作。
- **防止過熱保護裝置**：當熱交換器燒毀或溫度高於設計溫度時，裝置會啟動，並停止爐具運作。
- **防止過高水壓保護裝置**：當爐具內的水壓高於設計水壓，位於熱水出口的水洩壓閥會打開洩壓，並於水壓降回設計水壓時關閉。
- **水流量感應裝置**：當冷水水流受到阻隔或被中止，裝置會啟動，並停止爐具運作。
- **助燃風扇轉速檢查裝置**：裝置利用轉速感應器監察風扇的轉速是否正常。當風扇轉速與要求轉速有所偏差時，信號會傳送到主控器以調整轉速。

調節熱水溫度提示

- 為配合在不同季節的沐浴使用，可透過面板控制器或遙控器（如適用），調節所需的熱水溫度。
- 在冬季偶有極寒冷的天氣，自來水的溫度可能過低或熱水流量過大，爐具的出水溫度可能會比較低，可透過調節水龍頭或花灑掣減少熱水流量，以便獲得適合的水溫。
- 在夏季偶有極炎熱的天氣，自來水的溫度可能過高或熱水流量過小，爐具的出水溫度可能會比較高，可透過調節水龍頭或花灑掣輔以混合冷水，以便獲得適合的水溫。

保養

- (1) 爐具機身不可用溶劑清潔，應使用濕軟布指抹，再用乾軟布抹乾。
- (2) 避免向爐具機身噴水。
- (3) 如花灑出水量變少，花灑頭的水孔可能已堵塞。應檢查並加以清理。
- (4) 必須定期檢查及保養爐具，以確保使用上的安全及效率。

故障處理

安全裝置會持續監察爐具運作的狀況。當故障發生時，故障代碼會立即顯示在溫度顯示上。當致電維修服務時，請說出故障時所顯示號碼。

故障號碼	故障內容	處理方法
10	進風或排氣出現問題	請致電維修服務
11	點火失誤	關掉控制器，然後檢查供氣閥是否開啟，而煤氣供應是否中斷。若煤氣供應正常，重新開啟控制器，當開和關熱水龍頭數次後(每次開關相隔約10秒)，沒有出現故障顯示，說明熱水爐可以正常使用。如錯誤信息仍然存在，請致電維修服務。
12	熄火安全裝置啟動	請致電維修服務
14	殘火安全裝置或熱交換器過熱保護裝置啟動	請致電維修服務
16	過度沸騰保護裝置啟動	請致電維修服務
32	出水溫度感應器故障	請致電維修服務
34	空氣溫度感應器故障	請致電維修服務
61	助燃風扇故障	請致電維修服務
71	電控件故障	請致電維修服務
72	電控件故障	請致電維修服務

在一般情況下，關閉熱水水龍頭然後重新開啟，故障代碼有可能消除。若故障代碼仍然存在，可先嘗試關閉供電電源，等待 10 秒後重新啟動爐具。如故障代碼繼續存在，請致電煤氣公司客戶服務熱線 2880 6988。

在寒冷及潮濕的天氣，煙道出口偶會冒出煙霧，這是煙氣中的水氣遇冷而形成白色煙霧，此屬正常現象。

故障處理

關於熱水供應及溫度

沒有熱水供應

- 檢查供氣是否正常及有否出現中斷。
- 檢查水龍頭是否出水正常。
- 檢查冷水過濾網是否被堵塞。
- 檢查供電是否正常。
- 完全開啟煤氣錶閥及 / 或爐具供氣閥。
- 完全開啟冷水水掣及 / 或熱水水龍頭。
- 啟動爐具電源後，並按面板控制器或遙控器（如適用）上的開/關按鈕。

熱水沒有即時流出

- 啟動電源後，按面板控制器或遙控器（如適用）上的開/關按鈕。
- 從爐具到熱水水龍頭間存在一段距離，因此熱水未能即時流出。

熱水流量出現變化

- 如爐具正於一個水龍頭供應熱水，並於另一個水龍頭需同時供應熱水時，熱水水流量會減少。而因應供水水壓及水管狀況，有機會出現熱水水流量驟降或水流斷續的情況。待供水水壓及水管狀況穩定後，熱水水流會穩定下來。
- 因不同水龍頭產品於特性上有所差異，熱水水流量的改變有機會屬個別產品的特性。例如：熱水水流於剛流出時會較多，後續水流將趨於穩定。

熱水溫度過高

- 完全開啟冷水水掣及 / 或熱水水龍頭。
- 檢查所設定的熱水溫度是否適當。
- 在夏季偶有極炎熱的天氣，自來水的溫度可能過高或熱水流量過小，爐具的出水溫度可能會比較高，您可以調節水龍頭或花灑掣輔以混合冷水，以便獲得適合的水溫。

熱水溫度過低

- 完全開啟煤氣錶閥及 / 或爐具供氣閥。
- 檢查所設定的熱水溫度是否適當。
- 在冬季偶有極寒冷的天氣，自來水的溫度可能過低或熱水流量過大，爐具的出水溫度可能會比較低，您可以調節水龍頭或花灑掣來減少熱水水流量，以便獲得適合的水溫。

關於熱水供應及溫度

- 熱水溫度不穩定
- 完全開啟供水主閥，確保供水壓力足夠。
 - 增加混合水龍頭的熱水量，避免因熱水流量低於最低熱水流量，而導致燃燒器關閉。
- 不能調節熱水溫度設定
- 爐具運作時，熱水溫度只可設定為 48°C 或以下。如熱水溫度已設定為 50°C 或以上，熱水溫度只可調低。

關於面板控制器、遙控器（如適用）及爐具運作

- 開/關指示燈沒有亮起
- 檢查供電是否正常。
 - 啟動爐具電源後，並按面板控制器上的開/關按鈕。
- 熱水溫度設定自行變更
- 當爐具處於備用狀態超過 10 分鐘，如設定溫度為 50°C 或以上時，溫度設定將變更為 48°C。
- 沒有使用熱水，但風扇仍然運作
- 燃燒器關閉後，助燃風扇仍維持短暫運作，此屬正常運作。
- 使用中途熄火
- 完全開啟煤氣錶閥及 / 或爐具供氣閥。
 - 檢查供氣是否正常。
 - 完全開啟冷水水掣及 / 或熱水水龍頭。
 - 檢查水龍頭是否出水正常。
- 排煙管出口冒出煙霧
- 在寒冷及潮濕的天氣，煙氣中的水氣遇冷形成白色煙霧，此屬正常現象。
- 熱水出水變為白色並出現渾濁情況
- 水中溶解的空氣受熱後，形成氣泡，此屬正常運作。
- 偶然於水洩壓閥出口短暫流出水份
- 爐具內水壓高於設計水壓，位於熱水出口的水洩壓閥會打開洩壓，並於水壓降回設計水壓時關閉。

規格

型號		RS11TM	RS11RM	
基本規格	爐具類別	機動排煙密封式		
	安裝方式	掛牆式		
	排氣方式	頂排	背排	
	尺寸 - 闊 x 高 x 深 (毫米)	370 x 675 x 135		
	重量 (千克)	15	14.5	
	燃氣種類	香港煤氣		
	供氣壓力 (千帕)	1.5		
	燃氣接駁	3/4" BSP		
	水管接駁	冷水	1/2" BSP	
		熱水	1/2" BSP	
	供電及信號接駁	電源	交流電 220 伏特 50 赫	
		信號線	/	
	煙道接駁	出口	圓形	
		直徑	進風接口：Ø100 / 排氣接口：Ø60	進風接口：Ø110 / 排氣接口：Ø75
		長度	最長 5 米及 3 個彎位 (1 個彎位約等於 2 米長度)	/
	點火方式	自動電子點火		
	額定熱負荷 (千瓦)	最高	26.7	26.7
		最低	6.5	
耗電量 (瓦)	49			
防水能力	機身	IPX4		
	遙控器	/		
系統運作	熱水供應能力 25°C 升溫 (公升/分鐘)	12.0	12.0	
	熱水供應量範圍 (公升/分鐘)	2.4 至 12.0	2.4 至 12.0	
	最低熱水流量 (公升/分鐘)	2.4		
	最低運作水壓 (千帕)	10		
	建議運作水壓範圍 (千帕)	70 至 700		
	熱水水溫選擇 (°C)	35 至 48、50 及 55		
安全裝置	熄火安全裝置	火焰感應棒		
	殘火保護裝置	雙金屬開關 (90°C)		
	防止過度沸騰保護裝置	熱敏電阻 (95°C)		
	防止過熱保護裝置	熱斷流器 (150°C)		
	防止過高水壓保護裝置	水洩壓閥 (啟動：2100 千帕)		
	水流量感應裝置	水流感應器		
	助燃風扇檢測裝置	轉速感應器		
	電流過大保護裝置	保險絲 (3A)		
	漏電保護裝置	漏電斷路器		
配件	遙控器 (有線) ※可供選購	/		

爐具符合香港電氣產品 (安全) 規例。

Contents

Important Safety Instructions	P. 1
Product Descriptions	P. 5
Operating Instructions	P. 6
Maintenance	P. 8
Trouble Shooting	P. 9
Specifications	P. 12

Attention!

According to the Gas Safety Ordinance of Hong Kong, any gas installation works including the installation of appliances and connection tubing, must be undertaken by registered gas installers who are registered for that appropriate classes and be employed by registered gas contractor.

Important Safety Instructions







In order to use this appliance safely, please be sure to follow the below guidelines. The following guidelines have an important bearing on safety. Symbols and their meanings are as below.

Danger	If you ignore this warning sign and act mistakenly, it may incur death, or serious injury and will lead to an imminent danger of fire breaking out.
Warning	If you ignore this warning sign and mistakenly handle the appliance, it may incur death or serious injury and may lead to fire incident.
Caution	If you ignore this warning sign and mistakenly handle the appliance, this may incur injury or property damage.

The above injuries and properties damage refer specifically to the following descriptions.

- Injury: injuries, burns and electric shocks etc. that require treatment in hospital or long-term hospitalization.
- Properties Damage: widespread damage to house and furnishings.

In this user instructions includes different symbols, please refer to the following descriptions for the meanings of corresponding symbols.

					
Danger, warning,	Forbidden	Do not touch	Be sure to do	Disassembly is forbidden	Must be earthed

Danger

If you notice following problems with this appliance



- If you notice abnormal flames, gas smell or strange sounds when using the appliance, please turn off hot water tap and gas meter valve immediately and contact the Towngas company.
- In the event of earthquake or fire, cease operation without hesitation.



1. Turn off hot water tap

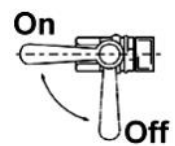

2. Turn off gas meter valve



Do not place the outlet of flue terminal indoor

- The outlet of flue terminal should be faced outdoor.



Important Safety Instructions



Danger



If you notice a gas leak

1. Cease use and turn off the gas meter valve.

2. Open all windows to disperse the gas.

3. Call Towngas Emergency Hotline on 2880 6999 with a phone outside the premises.

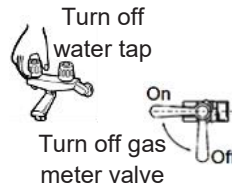

If there is a gas leak



- Do not ignite a fire, insert or remove power plug.
- Turning on or off any electrical appliance is forbidden.
- Do not use telephone or mobile phone nearby.



Do not perform any of the above actions or turn on the gas meter valve again until the gas leak is fixed.



Warning

Care to be taken with children



- When filling hot water into the bath-tub, do not allow children to play in the bathroom to avoid the children falling into the bath-tub or causing any dangers.
- Do not allow children to bath without the supervision of adult.

Self disassembling, repairing and modification of appliance are strictly forbidden



- Gas installer, who performs any installation, maintenance and its related work of appliance, shall be employed by registered gas contractor and be registered under appropriate class of gas installation work to prevent hazard or damage of appliance.

Do not cover outlet of flue terminal



- Do not place the outlet of flue terminal in an indoor environment due to additions or reconstruction in order to avoid the occurrence of carbon monoxide poisoning or fire hazard.



Important Safety Instructions



Caution

Regarding installation



- Do not install the appliance at outdoor.
- Minimize pipe length and avoid dead legs and stagnant corners in hot water pipework.
- Minimize the distance between hot water outlet and water tap.
- When installing the flue terminal, make sure the flue gas does not discharge directly to the outside walls, windows, glass, mesh doors or aluminum sashes etc. This could cause material disfiguration or discolouration.

What you must do to prevent fire



- Do not place flammable materials, such as paper, wood or clothes, around the appliance or flue terminal.
- Do not place or use volatile materials, such as gasoline or benzene, around the appliance or flue terminal.
- Do not place or use spray cans, such as hair spray or spray cleaners, around the appliance or flue terminal.

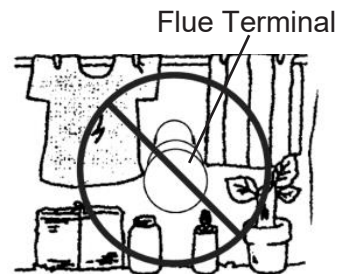

Flue Terminal

Regarding use



- This appliance is intended for residential application only. Do not use it for commercial application lest its service life is shortened.
- Do not use water from the appliance for drinking or cooking.
- This appliance is intended for supplying hot water to bathroom and kitchen. Do not use it for other purpose in order to avoid incident or damage of appliance.

What you must do to prevent scalding



- When turning on the tap again after using hot water or quickly reducing the hot water flow, relatively high-temperature hot water may suddenly come out. As there is a risk of being scalded, do not direct the hot water onto your head or body.
- When using the shower, relatively high-temperature hot water may come out first. In order to prevent scalding, check the hot water temperature with hand first. Do not direct the hot water onto the head or body.



Check hot water temperature with hand first



- Do not touch the flue terminal to prevent from scalding.



Do not touch flue terminal

Important Safety Instructions



Caution

Regarding control unit of appliance



- Keep the front panel control or remote control (if applicable) out of reach of children. It is intended to prevent accidents or damage of appliance.

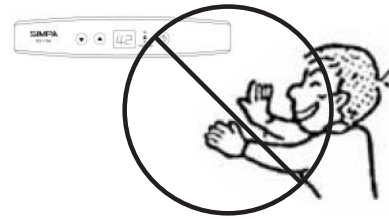

Regarding operation



- If appliance is not used for more than one week, drain away stagnant water inside the water pipework before use.
- During water purging, generation of water mist or splash should be avoided.
- Method of water purging: Turn off the appliance, fully turn on the most distant hot water tap from the appliance for 1 minute.
- To save energy, switch off appliance completely when hot water is not used.

Regarding cleaning and maintenance



- If the appliance or pipework circuits are in contact with chlorine-based fungicides, acidic bathroom cleaners, deodorants or salt, wash them off with ample water straight away to prevent causing accidents or damage of appliance.
- Do not use solvent or oil-based cleaners to clean the appliance. This could cause discolouration or disfiguration of appliance.
- Use only genuine parts for this appliance to prevent causing accidents or damage of appliance.

Product Descriptions

RS11TM / RS11RM

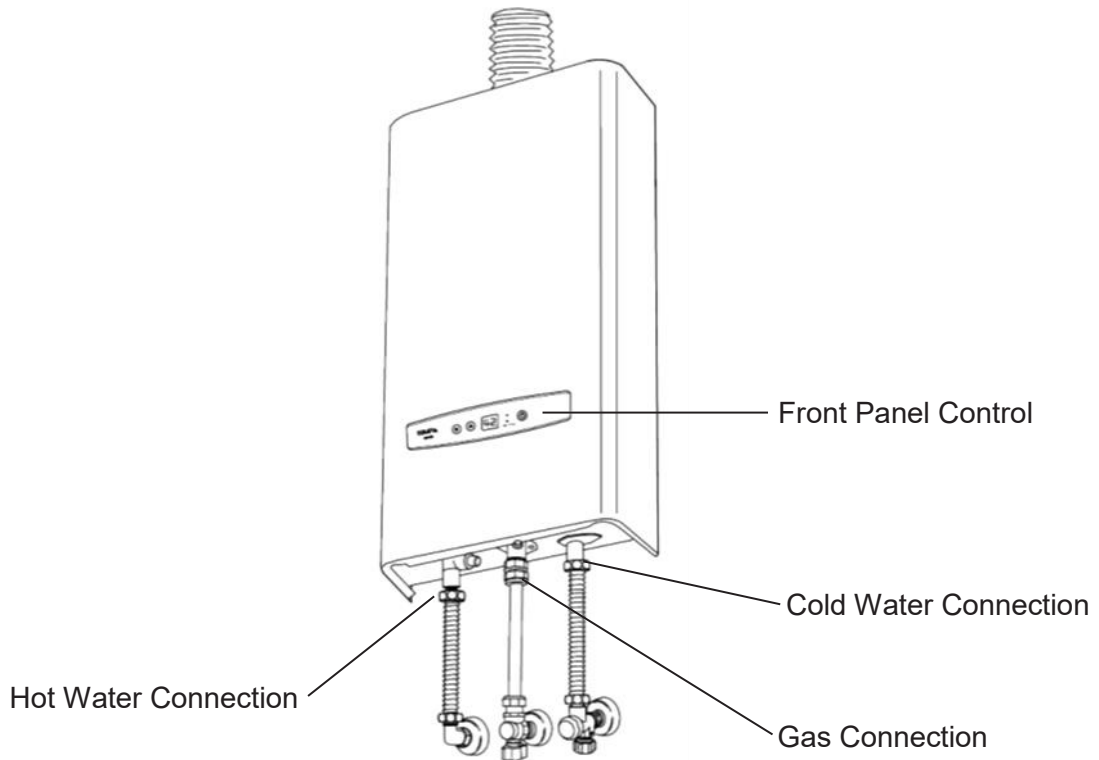

Front Panel Control

Temperature Display

- Display setting of hot water temperature.
- Error code will be displayed when the appliance malfunctions.

Operation Indication

- Indicator lights up during operation.

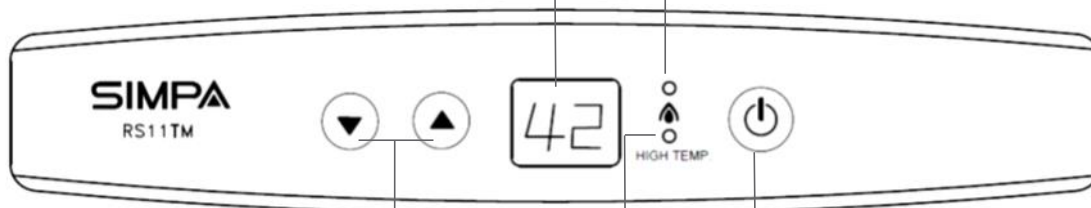

Temperature Setting Button

- Use for adjusting hot water temperature.

ON/OFF Button

- Use for turning on or off appliance.
- Press the button to turn on appliance, temperature display lights up.

High Temperature Indicator

- Indicator is lit when temperature setting is 50°C or above.

Operating Instructions

Caution

- When using the appliance for the first time or in the morning, the burner may not be ignited instantly because there may be some air remained inside the gas pipe. Please turn off the hot water tap and wait for 10 seconds, then turn on the hot water tap again to repeat the auto-ignition process.
- To prevent scalding:
 - check hot water temperature with hand first before taking shower. Do not direct hot water onto the head or body directly.
 - after using high-temperature hot water, the high-temperature hot water still remains inside the water pipework. To use relatively low-temperature hot water again, check the temperature with hand first and wait for suitable temperature before use.
- Temperature display blinks when hot water temperature is set at 50°C or above. Be careful of using high-temperature hot water.
- In case of high water supply pressure, relatively loud sound of water flow may occur during the operation of appliance. This is a normal phenomenon.
- Turn off the cold water valve and the gas supply valve of appliance when it is not used for a long period of time.



Check hot water temperature with hand first

First Time Usage of Appliance

Check the appliance by following instructions.

- Set the hot water temperature at 35°C. Fully turn on the hot water tap and turn off after confirming the hot water is running out.

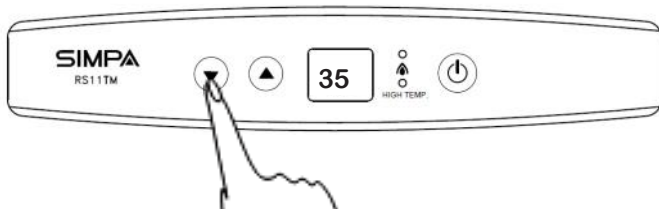

RS11TM

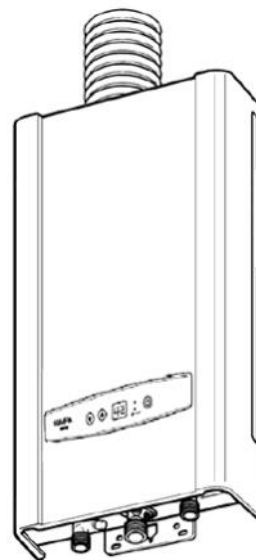

RS11RM

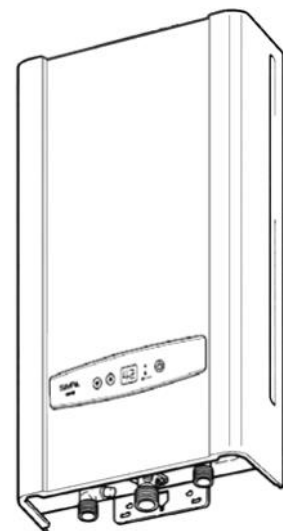

Operating Instructions

Use of Appliance

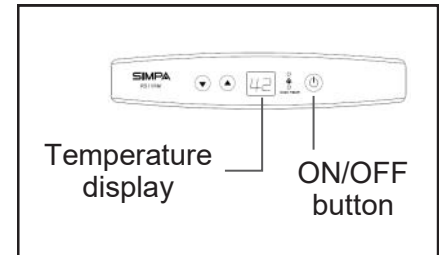

(1) Starting up appliance

- After turning on the power supply of appliance, press the ON/OFF button on front panel control or remote control (if applicable).
- Temperature display lights up. Appliance is under standby mode.
- First time usage after new installation, default hot water temperature is 42°C.



(2) Setting hot water temperature

- Pressing temperature adjusting buttons to adjust hot water temperature.

Increase hot water temperature 	Decrease hot water temperature 
Highest water temperature setting: 55°C	Lowest water temperature setting: 35°C
Range of adjustment of hot water temperature	
35 37 38 39 40 41 42 43 44 45 46 47 48 50 55	

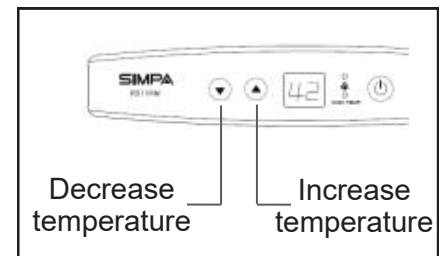

- High temperature indicator is lit when hot water temperature is set at 50°C or above.

(3) Using hot water

- After turning on hot water tap, burner will be ignited automatically and hot water will be supplied. Operation indicator lights up.
- Burner will be turned off when the hot water flow is lower than the minimum hot water flow. Therefore, hot water tap should not be turned on insufficiently. Otherwise, ignition may fail or the flame may be extinguished during use.
- When appliance is in operation, hot water temperature can only be set at 48°C or below. If hot water temperature is set at 50°C or above, hot water temperature can only be decreased.

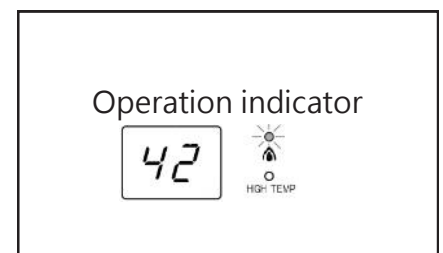

(4) Stopping use of hot water

- Appliance stops operation immediately and hot water flow stops when the hot water tap is turned off. Operation indicator will go out.
- To use hot water again, repeat step (1) to (3).
- Press the ON/OFF button on front panel control or remote control (if applicable) can turn off the appliance. Temperature display and operation indicator go out.

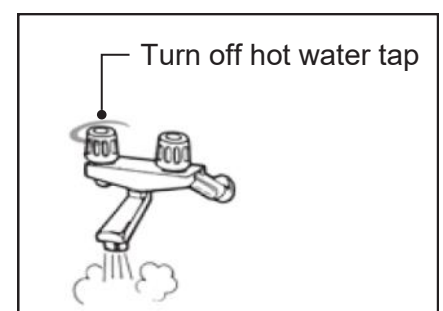

Operating Instructions

Safety Device

- **Flame failure safety device:** Using the flame rod sensor to monitor whether the combustion status is normal. When the flame fails, signal will be sent to the main controller to stop gas supply.
- **Remaining flame protection device:** If the flame still remains with the hot water temperature inside the heat exchanger has reached the design temperature after the hot water tap has been turned off, the device will activate and stop the operation of appliance.
- **Over boiling protection device:** If the hot water temperature is higher than the design temperature, the device will activate and stop the operation of appliance.
- **Over heat protection device:** If the heat exchanger burns out or the temperature reaches the design temperature, the device will activate and stop the operation of appliance.
- **Over pressure protection device:** If the water pressure inside the appliance is over the design pressure value, the pressure relief valve located near the hot water outlet will be opened to release pressure. After reducing to the design pressure value, it will then be closed.
- **Water flow sensing device:** If the cold water flow becomes restricted or stopped, the device will activate and stop the operation of appliance.
- **Combustion fan revolution checking device:** Using the revolution sensor to monitor whether the revolution of fan is normal. When the revolution of fan deviates from the required speed, signal will be sent to the main controller to adjust the revolution.

Reminder of Adjusting Hot Water Temperature

- To suit bathing purpose of different seasons, you may adjust hot water temperature through front panel control or remote control (if applicable).
- In winter, there may be occasional extremely cold weather where supply water temperature is exceptionally low or required water flow is too high. Hot water temperature of appliance may be relatively low. You may appropriately reduce the hot water flow by adjusting water faucet or shower tap to attain the suitable water temperature.
- In summer, there may be occasional extremely hot weather where supply water temperature is exceptionally high or required water flow is too low, hot water temperature of appliance may be relatively higher. You may appropriately increase the hot water flow or mixing with cold water by adjusting water faucet or shower tap to attain the suitable hot water temperature.

Maintenance

- (1) Never use solvents to clean the body of appliance. Please wipe the surface with a soft damp cloth, then dry with a soft cloth.
- (2) Avoid spraying water onto the body of appliance.
- (3) If the water flow at shower head is reduced, the holes of shower head may be blocked. It should be checked and cleaned.
- (4) It is necessary for the appliance to be inspected and maintained regularly so that it can be used safely and efficiently.

Trouble Shooting

Safety devices will keep monitoring the operation status of appliance. If a fault occurs, a fault code will be displayed on the temperature display. Please quote the code displayed when contacting customer service.

Fault Code	Details of Failure	Remedy
10	Abnormal air supply and flue exhaust	Contact Towngas Customer Service
11	Ignition failure	Turn off control unit, and then check whether the gas valve is opened and the gas supply is not interrupted. If gas supply is normal, press ON/OFF button to switch on water heater. If there is no error display when the hot water tap is opened or closed several times (wait for 10 seconds for each interval), the unit is operating normally. If the error message still persist, contact Towngas Customer Service.
12	Flame failure device activate	Contact Towngas Customer Service
14	Remaining flame safety device or heat exchanger overheat protection device activate	Contact Towngas Customer Service
16	Over boiling protection device activate	Contact Towngas Customer Service
32	Outgoing water temperature sensor faulty	Contact Towngas Customer Service
34	Air temperature sensor faulty	Contact Towngas Customer Service
61	Trouble with combustion fan	Contact Towngas Customer Service
71	Trouble with operating controls	Contact Towngas Customer Service
72	Trouble with operating controls	Contact Towngas Customer Service

In general cases, fault may be eliminated by turning off and then turning on the hot water tap again. If the fault cannot be eliminated, try to turn off the power supply and wait for 10 seconds before turning on the appliance again. If the fault still persists, please contact Towngas Customer Service Hotline on 2880 6988.

In cold and humid weather, cloudy mist may occasionally emerge from the flue terminal. The white mist is the condensate of water vapour in flue gases. This is a normal phenomenon.

Trouble Shooting

Issues of hot water supply and temperature

- | | |
|-----------------------------------|--|
| No hot water supplied | <ul style="list-style-type: none">• Check if the gas supply is normal and without suspension.• Check if the water is running out from water tap normally.• Check if the cold water filter is being blocked.• Check if the power supply is normal.• Fully turn on the gas meter valve and/or gas supply valve of appliance.• Fully turn on the cold water valve and/or hot water tap.• After turning on the power supply of appliance, press the ON/OFF button on front panel control or remote control (if applicable). |
| No hot water supplied immediately | <ul style="list-style-type: none">• After turning on the power supply, press the ON/OFF button on front panel control or remote control (if applicable).• There is a distance between the appliance and the hot water tap, therefore, hot water cannot be supplied immediately. |
| Hot water flow is fluctuated | <ul style="list-style-type: none">• When the appliance is supplying hot water to a water tap with another water tap using hot water at the same time, the hot water flow will be reduced. Depending on the conditions of water supply pressure and pipework, hot water flow may be reduced suddenly or with a discontinued water flow situation. After the conditions of water supply pressure and pipework are stabilized, hot water flow will be stable.• Due to the differences in product features of water tap, variation of hot water flow may be special feature of particular product. For example: hot water flow will be higher at the beginning and water flow will be stabilized afterward. |
| Hot water temperature is too high | <ul style="list-style-type: none">• Fully turn on the cold water valve and/or hot water tap.• Check if the set hot water temperature is appropriate.• In summer, there may be occasional extremely hot weather where supply water temperature is exceptionally high or required water flow is too low, hot water temperature of appliance may be relatively higher. You may adjust water faucet or shower tap to mix with cold water for attaining suitable water temperature. |
| Hot water temperature is too low | <ul style="list-style-type: none">• Fully turn on the gas meter valve and/or gas supply valve of appliance.• Check if the set hot water temperature is appropriate.• In winter, there may be occasional extremely cold weather where supply water temperature is exceptionally low or required water flow is too high, hot water temperature of appliance may be relatively less. You may appropriately reduce the hot water flow by adjusting water faucet or shower tap to attain the suitable water temperature. |

Trouble Shooting

Issues of hot water supply and temperature

- | | |
|--|--|
| Hot water temperature is unstable | <ul style="list-style-type: none">• Fully turn on the main water supply valve to ensure sufficient water pressure.• Increase hot water flow of mixing-type faucet to avoid the hot water flow lower than the minimum hot water flow that burner will be turned off. |
| Unable to adjust hot water temperature setting | <ul style="list-style-type: none">• When appliance is in operation, hot water temperature can only be set to 48°C or below. If hot water temperature is set at 50°C or above, hot water temperature can only be decreased. |

Issues of front panel control, remote control (if applicable) and appliance operation

- | | |
|--|---|
| ON/OFF indicator does not light up | <ul style="list-style-type: none">• Check if the power supply is normal.• After turning on the power supply of appliance, press the ON/OFF button on front panel control. |
| Fan keeps operating without use of hot water | <ul style="list-style-type: none">• After the burner is closed, combustion fan will keep operating for a short period of time. This is a normal phenomenon. |
| Flame failure during usage | <ul style="list-style-type: none">• Fully turn on the gas meter valve and/or gas supply valve of appliance.• Check if the gas supply is normal and without suspension.• Fully turn on the cold water valve and/or hot water tap.• Check if the water is running out from water tap normally. |
| Cloudy mist emerges from flue terminal | <ul style="list-style-type: none">• In cold and humid weather, white mist is the condensate of water vapour in flue gases. This is a normal phenomenon. |
| Hot water turns milky with a cloudy status | <ul style="list-style-type: none">• Dissolved air in water is released as bubbles when heated. This is normal phenomenon. |
| Water is discharged momentarily from the outlet of pressure relief valve | <ul style="list-style-type: none">• If the water pressure inside the appliance is over the design pressure value, the pressure relief valve located near the hot water outlet will be opened to release pressure. After reducing to the design pressure value, it will then be closed. |

Specifications

Model		RS11TM	RS11RM	
Basic Specifications	Appliance Type	Fan Draught Room-sealed Type		
	Installation Type	Wall-mount Type		
	Flue Type	Top Flue	Back Flue	
	Dimensions - W x H x D (mm)	370 x 675 x 135		
	Weight (kg)	15	14.5	
	Gas Type	Hong Kong Town Gas		
	Gas Supply Pressure (kPa)	1.5		
	Gas Connection	3/4" BSP		
	Water Pipework Connections	Cold Water	1/2" BSP	
		Hot Water	1/2" BSP	
	Power Supply & Signal Connections	Power Supply	A.C. 220V 50Hz	
		Signal Cable	/	
	Exhaust Connections (mm)	Flue Terminal	Circular Type	
		Flue Diameter	Air Inlet Connection: Ø100 / Exhaust outlet Connection: Ø60	Air Inlet Connection: Ø110 / Exhaust outlet Connection: Ø75
		Flue Length	Maximum 5m & 3 bend (1 bend equivalent to 2m)	/
	Ignition Type	Automatic Spark Ignition		
	Rated Heat Input (kW)	Maximum	26.7	26.7
		Minimum	6.5	
	Electrical Consumption (W)	49		
	Level of Water-proof	Body	IPX4	
Remote Control		/		
Operation System	Amount of Hot Water Supply with 25°C Temperature Rise (L/min)	12.0	12.0	
	Amount of Hot Water Supply Range (L/min)	2.4 to 12.0	2.4 to 12.0	
	Minimum Hot Water Flow (L/min)	2.4		
	Minimum Operation Water Pressure (kPa)	10		
	Range of Normal Operation Water Pressure (kPa)	70 to 700		
	Range of Hot Water Temperature (°C)	35 to 48, 50 & 55		
Safety Devices	Flame Failure Safety Device	Flame Rod		
	Remaining Flame Protection Device	Bi-metal Switch (90°C)		
	Over Boiling Protection Device	Thermistor (95°C)		
	Overheat Protection Device	Thermal Fuse (150°C)		
	Over Pressure Protection Device	Pressure Relief Valve (ON: 2100kPa)		
	Water Flow Sensing Device	Water Flow Sensor		
	Combustion Fan Revolution Checking Device	Speed Detection Sensor		
	Over Electrical Current Protection Device	Fuse (3A)		
	Earth Leakage Protection Device	Earth Leakage Circuit Breaker		
Accessories	Remote Control (Wired) ※ Optional to purchase	/		

The appliances comply with the Electrical Products (Safety) Regulation in Hong Kong.



香港中華煤氣有限公司
The Hong Kong and China Gas Company Limited