



即熱式氣體熱水爐

Instantaneous Gas Water Heater

使用說明書

User Instructions

型號 Model

TRJW162TFQL / TRJW222TFQL

TRJW162TFL / TRJW222TFL

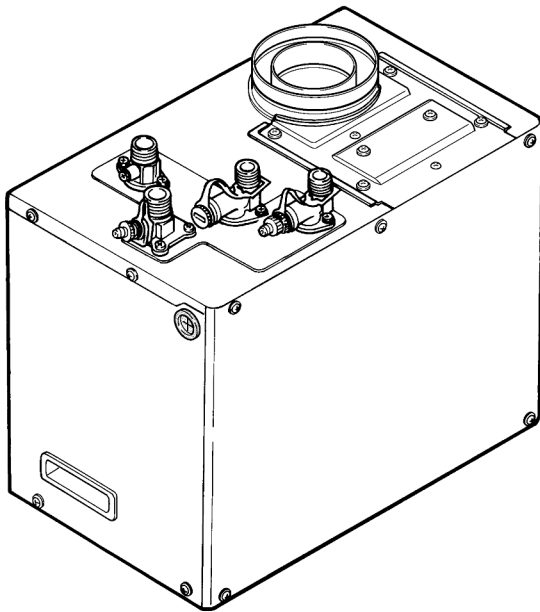

TRJW162TFQL

TRJW222TFQL

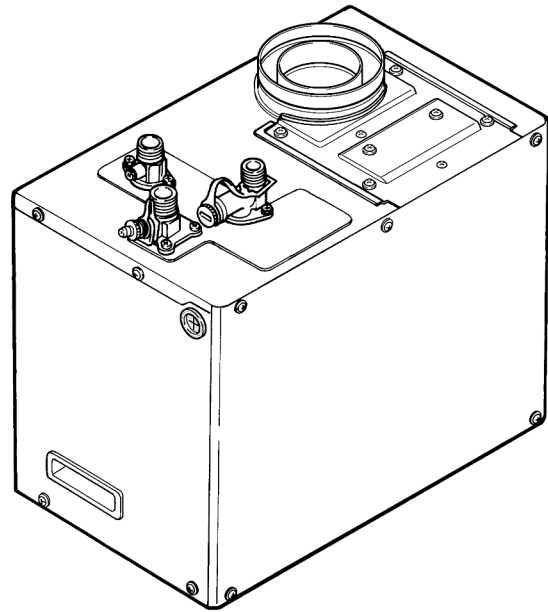

TRJW162TFL

TRJW222TFL

香港煤氣適用
For Hong Kong Town Gas

目錄



重要安全指示	第 1 頁
產品介紹	第 5 頁
操作指示	第 8 頁
保養	第 14 頁
故障處理	第 15 頁
規格	第 18 頁

注意!

根據香港氣體安全條例，任何氣體裝置工程，包括爐具和接駁喉管的安裝，必須由註冊氣體裝置技工執行，而該技工已於相關的氣體工程類別註冊及受聘於註冊氣體工程承辦商。

重要安全指示

為安全使用本爐具，請遵照下列各項指示。下列指示對安全有莫大關係，警示及其意思如下：

 危險	若忽視此警示，並作出錯誤行動，可能引致死亡或嚴重受傷和發生火警的危險。
 警告	若忽視此警示，並錯誤使用爐具，可能引致死亡或嚴重受傷，亦可導致火警發生。
 注意	若忽視此警示，並錯誤使用爐具，可能會引致受傷和財物損毀。

上述描述所導致的受傷及財物損毀情況，請參考下列詳細描述。

- 受傷：出現損傷、燙傷及觸電等情況，並須送院治理或長期留院治療。
- 財物損毀：對房屋及傢俱等物件造成廣泛損毀。

本說明書中包含不同警示，請參考下列有關警示意思的描述。



危險

若發現本爐具出現以下問題



- 當使用爐具時，若發現異常的火焰、氣味或特別的聲音，請立即關閉熱水水龍頭及煤氣錶掣，並通知客戶服務安排檢修。
- 在發生地震或火災時，請立即停止操作爐具。

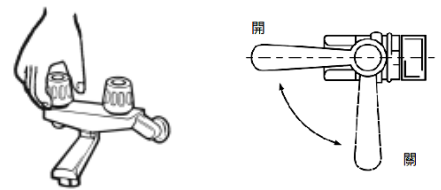

1. 關閉熱水水龍頭
2. 關閉煤氣錶掣



切勿將煙道的出口置於室內

- 煙道的出口必須面向室外地方。

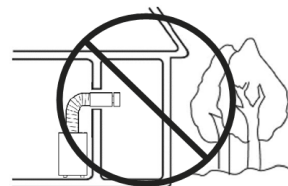

重要安全指示

危險



若你發覺有煤氣洩漏

1. 請停止使用本爐具，並關閉煤氣錶掣。
2. 開啟所有窗戶讓煤氣排出屋外。
3. 使用位於室外的電話與煤氣公司緊急事故熱線2880 6999 聯絡。

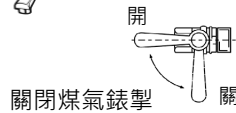

若發生燃氣洩漏



- 切勿點燃明火、插拔電源插頭。
- 禁止開啟或關閉電器產品。
- 切勿在附近使用電話、手機。



切勿在漏氣處理完畢前進行上述活動或再次打開煤氣錶掣。

警告

請小心看管兒童



- 注入熱水到浴缸時，切勿讓兒童在浴室玩耍，以免兒童不小心掉進浴缸或導致預計不到的意外發生。
- 切勿讓兒童於沒有成人監督下洗澡。

嚴禁自行拆卸、維修或改裝爐具



- 爐具的安裝、維修及其他附帶工程，必須由受僱於註冊氣體工程承辦商及領有適當類別的氣體裝置技工進行，以免造成危險或損毀爐具。

切勿遮蓋煙道出口



- 請勿因增建或改建等原因令煙道出口位於室內，以避免引致一氧化碳中毒或火警危險。



重要安全指示



注意

有關安裝

- 嚴禁安裝爐具於室外地方。
- 爐具必須在空氣流通的房間安裝及使用。
- 如爐具安裝在間隔室內，最少間隔室通風口需符合機電工程署〈工作守則：氣體應用指南之三〉內的要求。
- 請儘量縮短熱水喉管的長度，以及避免水管有可能導致閉塞及滯水的地方。
- 儘量縮短熱水出口與水龍頭的距離。
- 安裝煙道時，確保排出的煙氣不會直接排向外牆、窗戶、玻璃、鋼門或鋁窗框等物件，這或會引致這些物件出現變形及變色。



- 如圖所示，請將物件與爐具保持適當距離。

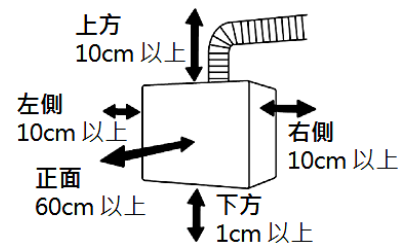

遵照下列指示，避免火警

- 切勿於爐具或煙道周圍擺放易燃物品，如紙張、木材或衣服。
- 切勿於爐具或煙道周圍擺放或使用揮發性物品，如汽油或揮發油。
- 切勿於爐具或煙道周圍擺放或使用噴霧罐，如噴髮劑或噴霧清潔劑。



有關用途

- 本爐具只供家居用途。為免縮短爐具的壽命，請勿用於商業用途。
- 請勿將流經本爐具的水用作飲用或煮食用途。
- 本爐具只作供應熱水給浴室或廚房使用，切勿用作其他用途，以免發生意外或損壞爐具。



遵照下列指示以防燙傷

- 當使用熱水後，立即重開熱水水龍頭或迅速減慢熱水流出時，較高溫的熱水有機會突然噴出。為避免燙傷危險，切勿將熱水直接噴灑在頭和身體上。
- 當使用花灑時，較高溫的熱水可能會先流出。為避免燙傷，請先用手確認水溫。切勿直接將熱水噴灑在頭和身體上。



先用手確認水溫



- 切勿觸摸煙道，避免燙傷。

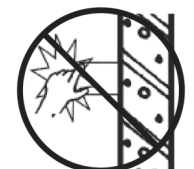

切勿觸摸煙道

重要安全指示



注意



有關爐具控制器

- 請勿讓小孩隨意按動爐具的遙控器。避免造成意外或損毀爐具。

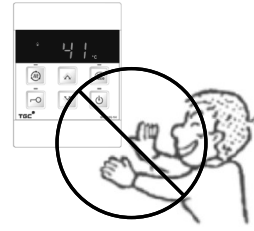

有關使用

- 若爐具已停用超過一星期，於使用前，應將滯留於水管內的水先排走。
- 進行排水時，應儘量避免產生水霧或水花。
- 排水方法 (ii 及 iii 項只適用於備有預熱循環功能的型號)



i) 關閉爐具，將距離爐具最遠的熱水水龍頭完全開啟1分鐘。

ii) 關閉熱水水龍頭，將水溫設定於 50°C，啟動爐具並啟動預熱循環功能運作 3 分鐘。

iii) 將水溫設定於 40°C，並完全開啟熱水水龍頭 1 分鐘。

- 節省能源及防止細菌滋生，不應長時間於不使用熱水的情況下啟動預熱循環功能。不使用熱水時，應將爐具完全關閉。

有關清潔及保養



- 若爐具或喉管接觸到含氯除菌劑、酸性浴室清潔劑、除臭劑或食鹽，請用大量的清水把它們沖掉，避免造成意外或損毀爐具。
- 切勿使用溶劑或油性清潔劑清潔爐具，否則或會令爐具變色或變形。
- 請使用原廠零件及配件，避免造成意外或損毀爐具。

產品介紹

TRJW162TFQL / TRJW222TFQL

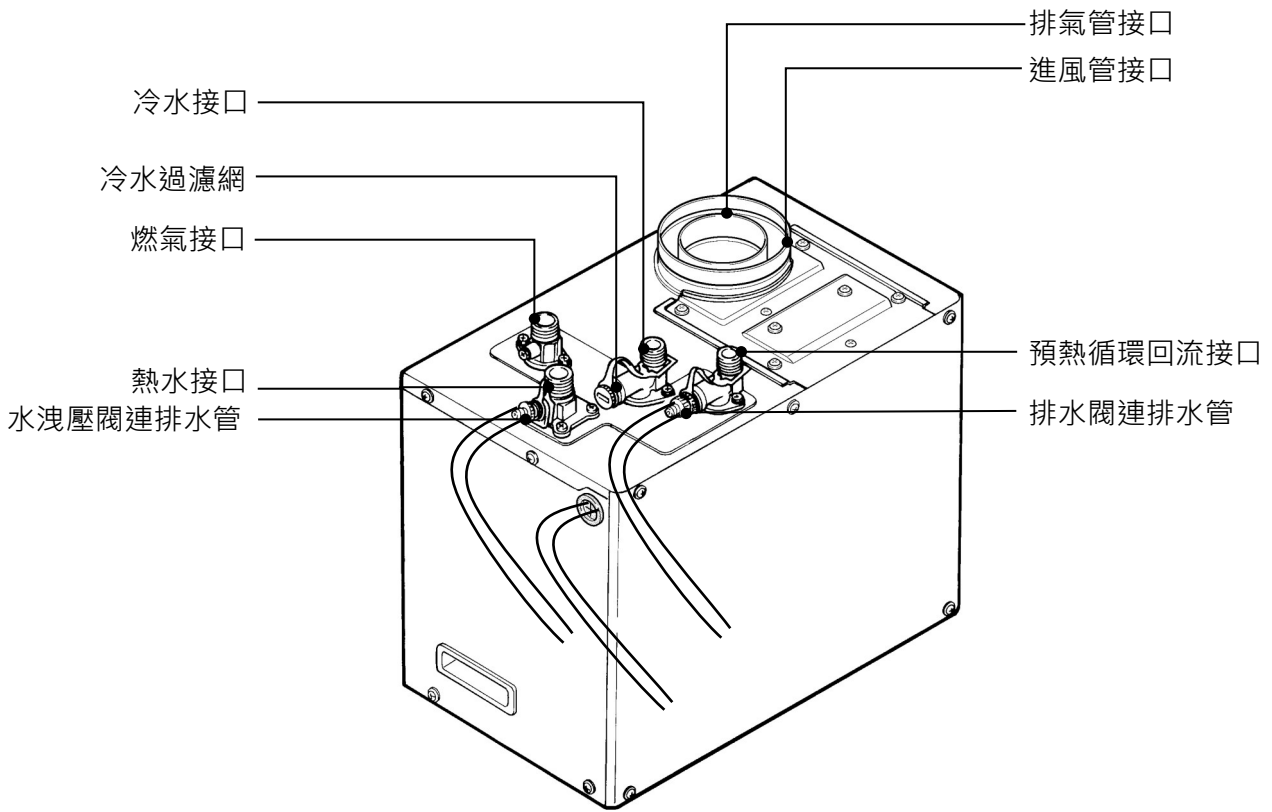

TRJW162TFL / TRJW222TFL

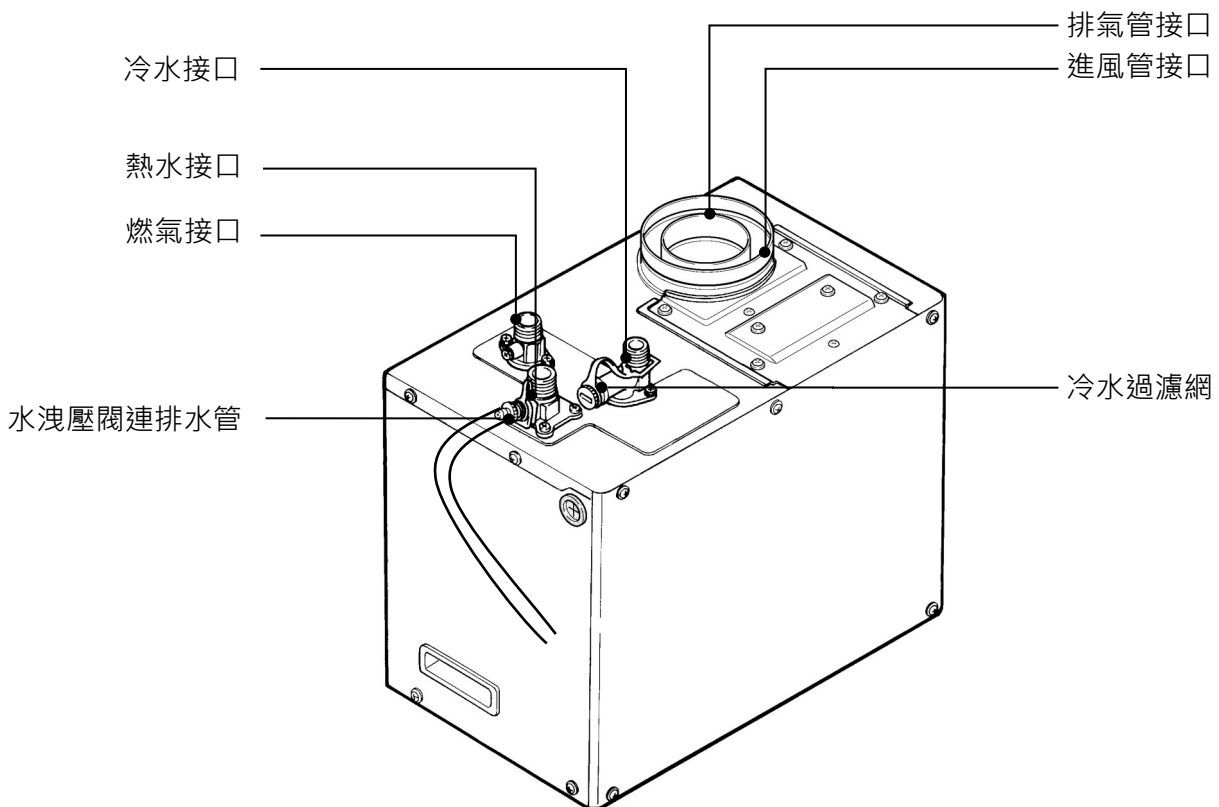

遙控器

TRJW162TFQL / TRJW222TFQL 遙控器配置

- 隨爐均附送浴室遙控器 (BC-602Q-1H) 1 個。
- 可額外選購遙控器。爐具最多可接駁3個遙控器。
- 爐具接駁2個遙控器時，須為1個浴室遙控器 (BC-602Q-1H)，另1個額外遙控器可為1個浴室遙控器 (BC-602Q-1H) 或1個廚房遙控器 (MC-602-1H)。
- 爐具接駁3個遙控器時，須為2個浴室遙控器 (BC-602Q-1H) 及 1個廚房遙控器 (MC-602-1H)。

浴室遙控器

BC-602Q-1H



(隨爐附件)

浴室遙控器

BC-602Q-1H



(可供選購)

廚房遙控器

MC-602-1H

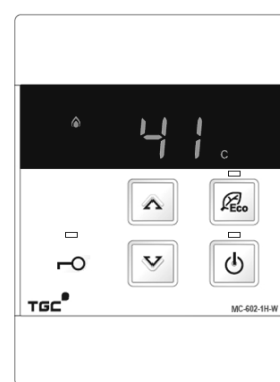

(可供選購)

TRJW162TFL / TRJW222TFL 遙控器配置

- 隨爐均附送浴室遙控器 (BC-602-1H) 1 個。
- 可額外選購遙控器。爐具最多可接駁3個遙控器。
- 爐具接駁2個遙控器時，須為1個浴室遙控器 (BC-602-1H)，另1個額外遙控器可為1個浴室遙控器 (BC-602-1H) 或1個廚房遙控器 (MC-602-1H)。
- 爐具接駁3個遙控器時，須為2個浴室遙控器 (BC-602-1H) 及 1個廚房遙控器 (MC-602-1H)。

浴室遙控器

BC-602-1H

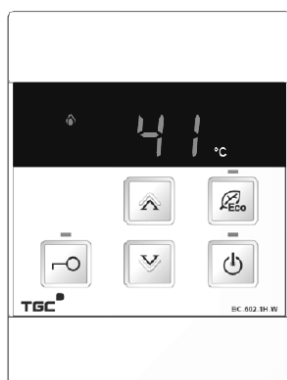

(隨爐附件)

浴室遙控器

BC-602-1H

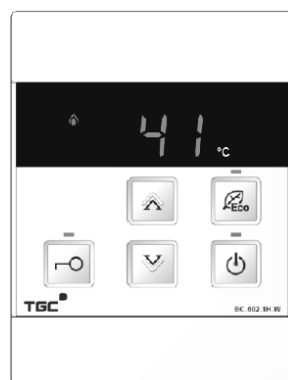

(可供選購)

廚房遙控器

MC-602-1H

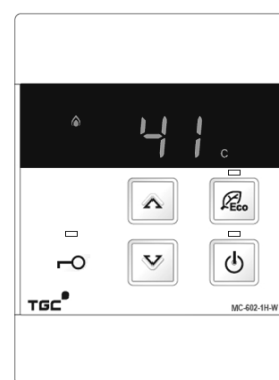

(可供選購)

產品介紹

遙控器

運作指示燈

- 運作時，橙色指示燈會亮著。

預熱循環按鈕及指示燈

- 用作啟動預熱循環功能。
- 按下按鈕啟動功能，綠色指示燈會亮著。
- 預熱循環溫度按擁有優先選控權的浴室遙控器設定，最高為 50°C。
- 當廚房遙控器擁有優先選控權時，預熱循環溫度則按之前擁有優先選控權的浴室遙控器設定，最高為 50°C。

優先按鈕 / 優先指示燈

浴室遙控器

- 用作轉變面板控制器或遙控器的優先選控權。
- 按下按鈕取得優先選控權。擁有優先選控權的遙控器，綠色指示燈會亮著。
- 熱水溫度可於優先指示燈亮著的面板控制器或遙控器調節。
- 指示燈閃爍時，優先選控權不可更改。
- 指示燈熄滅時，重按取回優先選控權。

廚房遙控器

- 只有優先指示燈。
- 擁有優先選控權的遙控器，綠色指示燈會亮著。

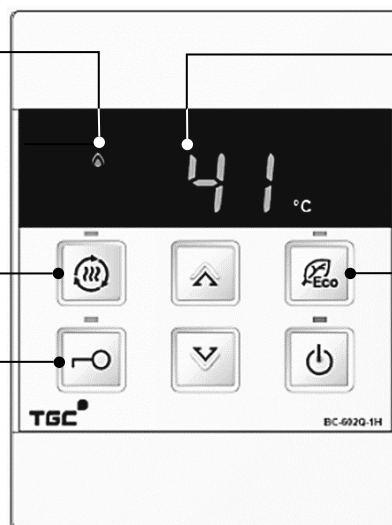

浴室遙控器: BC-602Q-1H

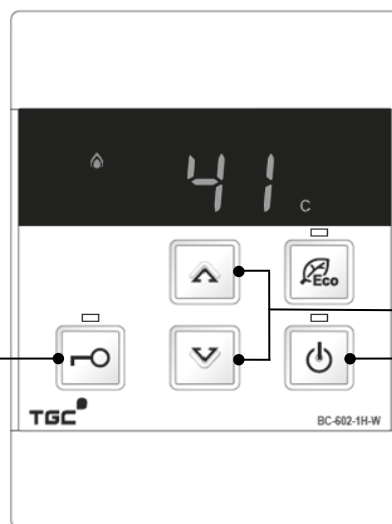

浴室遙控器: BC-602-1H

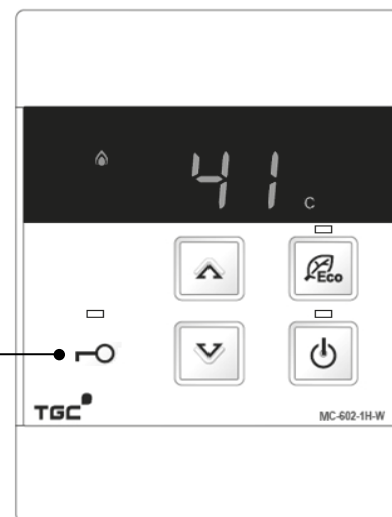

廚房遙控器: MC-602-1H

溫度顯示

- 顯示熱水溫度設定。
- 於爐具出現異常時顯示故障信號。
- 當熱水溫度設定為 50°C 或以上，溫度顯示會閃爍。

環保按鈕及指示燈

- 按下按鈕啟動環保 (Eco) 模式，綠色指示燈會亮著。

水溫設定按鈕

- 用作調節熱水溫度。

開/關按鈕及指示燈

- 用作啟動或關閉爐具。
- 按下按鈕啟動爐具，溫度顯示、開/關指示燈及綠色優先指示燈會亮著。
- 優先指示燈會亮著時，按下按鈕關閉爐具。

操作指示

注意

- 首次或於早上使用爐具時，供氣管道內有機會因殘留空氣而無法即時點燃燃燒器。請關閉熱水水龍頭，待 10 秒後再開啟熱水水龍頭，重複自動點燃程序。

- 為避免燙傷：

- 淋浴前請先用手確認水溫，切勿直接將熱水噴灑在頭和身體上。
- 使用高溫熱水後，水管中仍存有高溫熱水。再次使用較低溫的熱水時，應先用手確認水溫，待溫度適合後才使用。



先用手確認水溫

- 熱水水溫設定為 50°C或以上時，高溫指示燈會亮起。請小心使用高溫熱水。
- 在供水壓力較高的情況下，使用爐具時有機會出現較大的水流聲，此屬正常現象。
- 長時間不使用爐具時，請關閉冷水水掣及爐具供氣閥。



初次使用爐具

請按以下指示檢查爐具運作。

將熱水水溫調節至 35°C 的設定。完全開啟熱水水龍頭，並確認熱水流出後關閉。

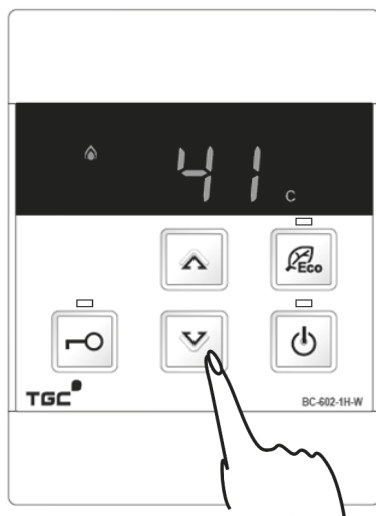

TRJW162TFQL
TRJW222TFQL

TRJW162TFL
TRJW222TFL

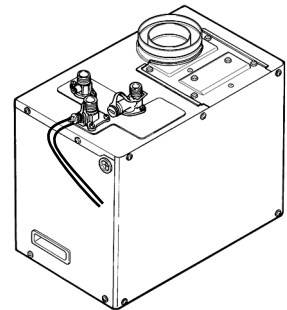
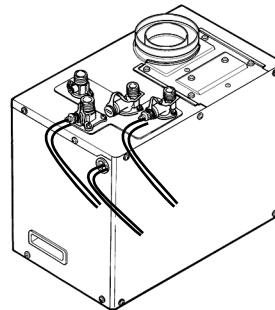

操作指示

使用爐具

(1) 啟動爐具

- 啟動爐具電源後，按面板控制器或遙控器上的開/關按鈕。
- 溫度顯示及開關指示燈亮起，此時爐具處於備用狀態。
- 用作啟動爐具的面板控制器或遙控器即擁有優先選擇權，優先指示燈會亮起。當優先指示燈閃爍時，優先選擇權不能轉換。
- 安裝後首次使用時，預設溫度為 42°C。

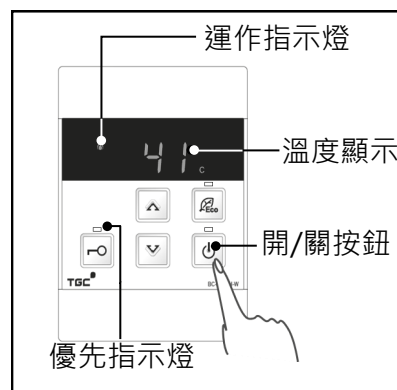

(2) 設定熱水水溫

- 利用擁有優先選擇權的遙控器可調節熱水水溫。

調高熱水水溫 	調低熱水水溫 
最高水溫設定：60°C	最低水溫設定：35°C
熱水水溫可調節範圍	
35 37 38 39 40 41 42 43 44 45 46 47 48 50 55 60	

- 熱水溫度設定為 50°C 或以上時，溫度顯示會閃爍。

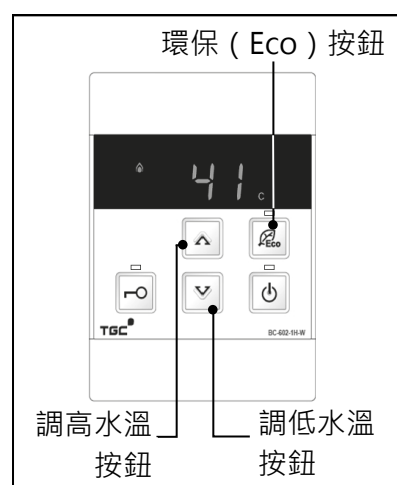

(3) 使用熱水

- 開啟熱水水龍頭後，燃燒器會自動點燃，熱水隨即流出，橙色運作指示燈會亮起。
- 熱水流量低於最低熱水流量時，燃燒器便會關閉。因此熱水水龍頭不宜開啓過小，否則使用時有機會出現無法燃點或中途熄火現象。
- 爐具運作時，熱水溫度只可設定為 48°C 或以下。如熱水溫度已設定為 50°C 或以上，熱水溫度只可調低。

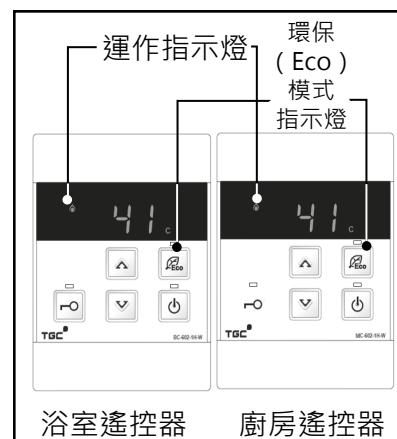

(4) 設定環保 (Eco) 模式

- 按環保 (Eco) 按鈕啟動環保 (Eco) 模式，其指示燈會亮起。
- 於環保 (Eco) 模式下，爐具最高水流量限制於 9 升 / 每分鐘。
- 所設定的熱水水溫不會受環保 (Eco) 模式的啟動而影響。
- 再按環保 (Eco) 按鈕取消環保 (Eco) 模式，其指示燈會熄滅。

(5) 停止使用熱水

- 關閉熱水水龍頭後，爐具立即停止運作，熱水停止流出。運作指示燈會熄掉。
- 需再次使用熱水時，重複步驟 (1) 至 (4)。
- 擁有優先選擇權的面板控制器或遙控器才能關閉爐具。按遙控器上的開/關按鈕，所有顯示及指示燈會熄滅。

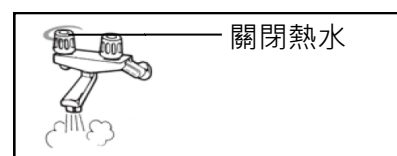
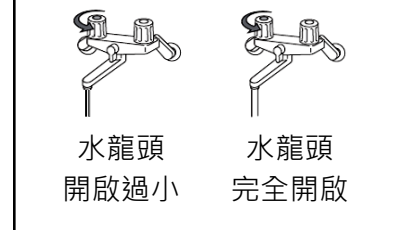

操作指示

轉換優先選控權 (安裝多個遙控器)

- 安裝兩個或以上 (最多三個) 的遙控器，只有擁有優先選控權的遙控器才可設定熱水溫度，以防止意外發生，如燙傷等。
- 當浴室遙控器擁有優先選控權，其優先指示燈會亮起，而其他遙控器上的優先指示燈會閃爍。
- 當廚房遙控器擁有優先選控權，其優先指示燈會亮起，而其他遙控器上的優先指示燈會熄滅。
- 利用浴室遙控器可轉換優先選控權至廚房遙控器。
- 優先選控權不能於優先指示燈閃爍時或爐具正在運作時轉換。
- 每個遙控器均可記存其之前擁有優先選控權所設定的溫度 (最高 48°C)，取得優先選控權時，先前溫度設定將顯示於溫度顯示。
- 當爐具處於備用狀態超過 10 分鐘，優先選控權會自動解除，所有優先指示燈會關掉。再使用爐具時，爐具會按照之前擁有優先選控權的遙控器所設定的溫度提供熱水。
- 設定溫度為 50°C或以上時，於優先選控權解除後，溫度設定將變更為 48°C。

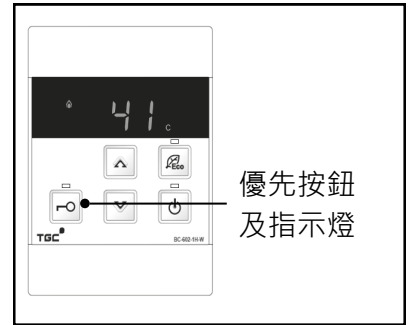

(1) 額外接駁 1 個浴室遙控器

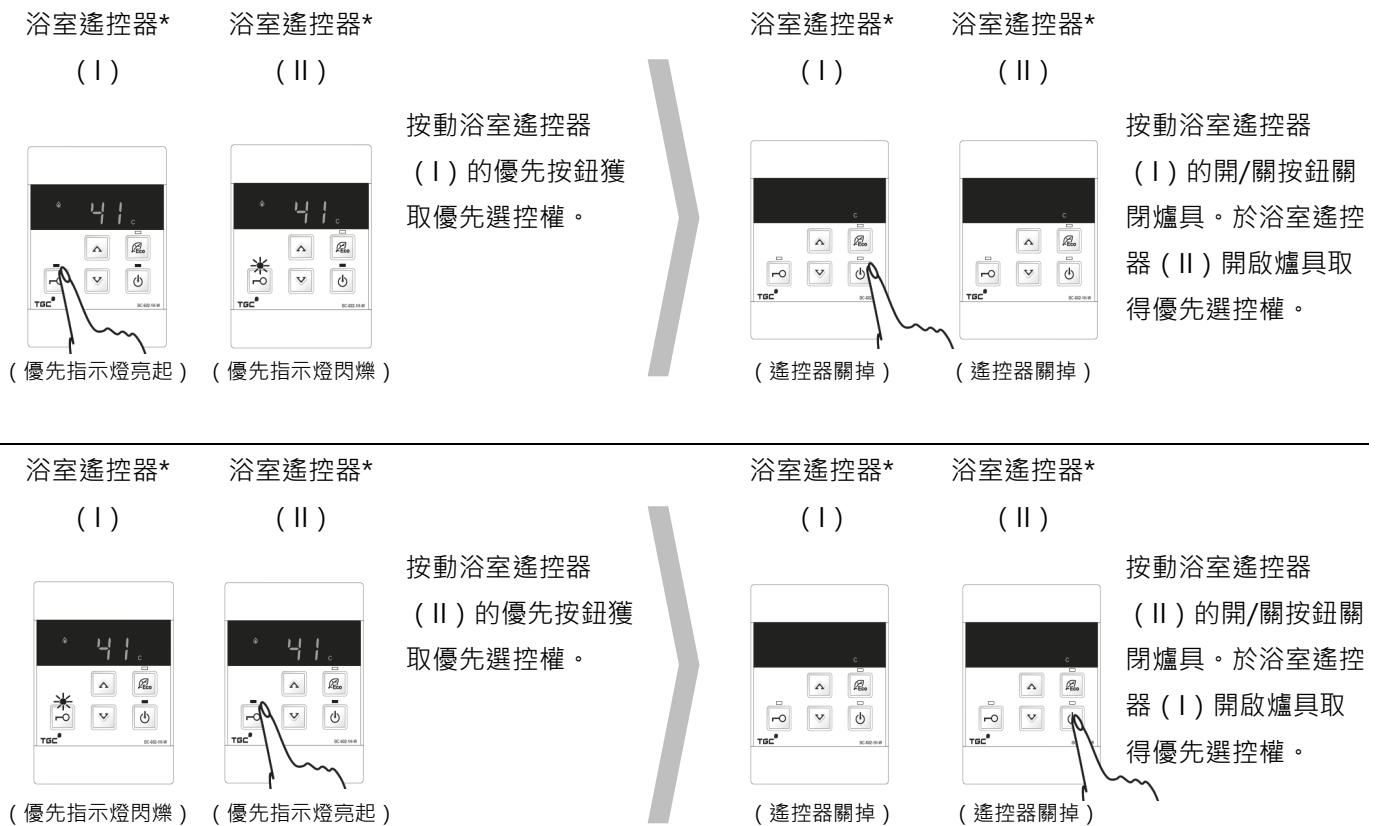

* TRJW162TFQL 及 TRJW222TFQL : 浴室遙控器 (I) 及 (II) 為 BC-602Q-1H。
TRJW162TFL 及 TRJW222TFL : 浴室遙控器 (I) 及 (II) 為 BC-602-1H。

轉換優先選控權 (安裝多個遙控器)

(2) 額外接駁 1 個廚房遙控器

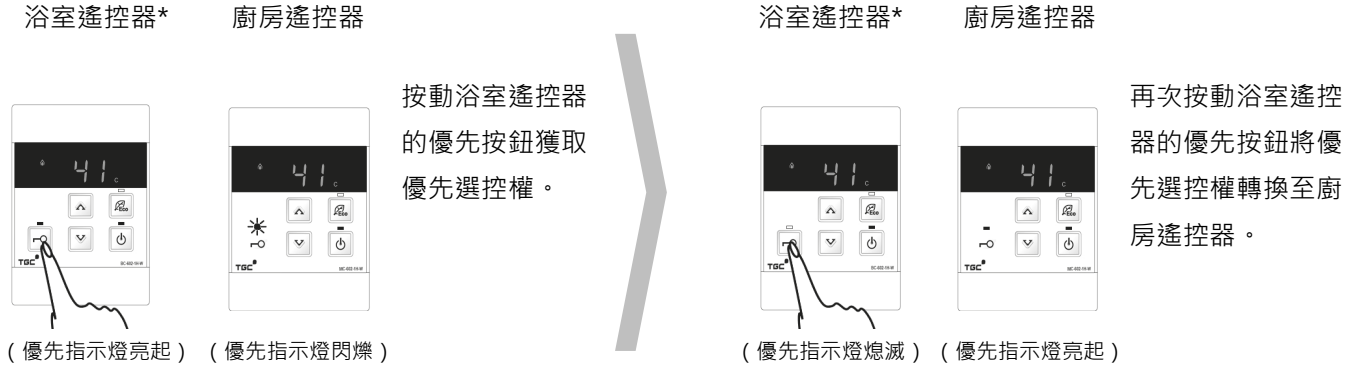

* *TRJW162TFQL* 及 *TRJW222TFQL* : 浴室遙控器為 *BC-602Q-1H* ;
TRJW162TFL 及 *TRJW222TFL* : 浴室遙控器為 *BC-602-1H* 。
 廚房遙控器為 *MC-602-1H* 。

(3) 額外接駁 2 個遙控器

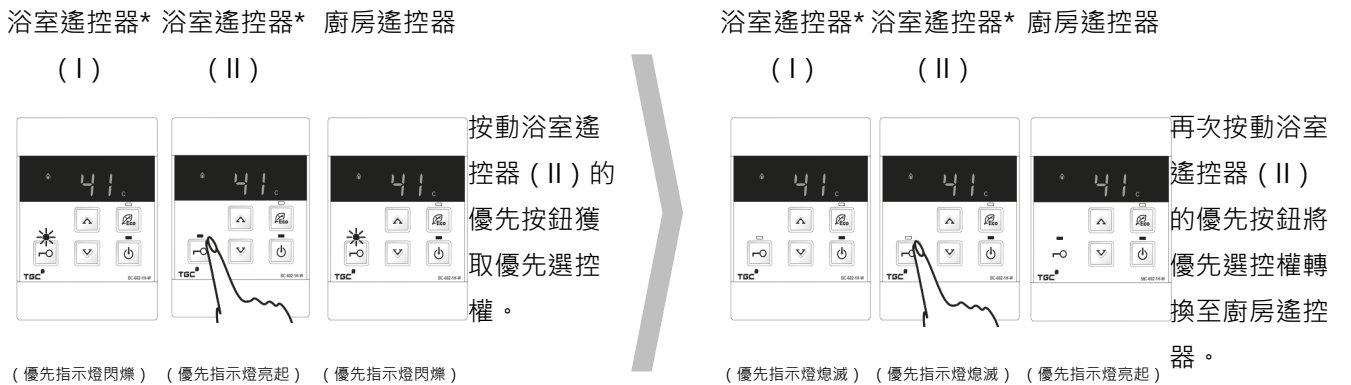
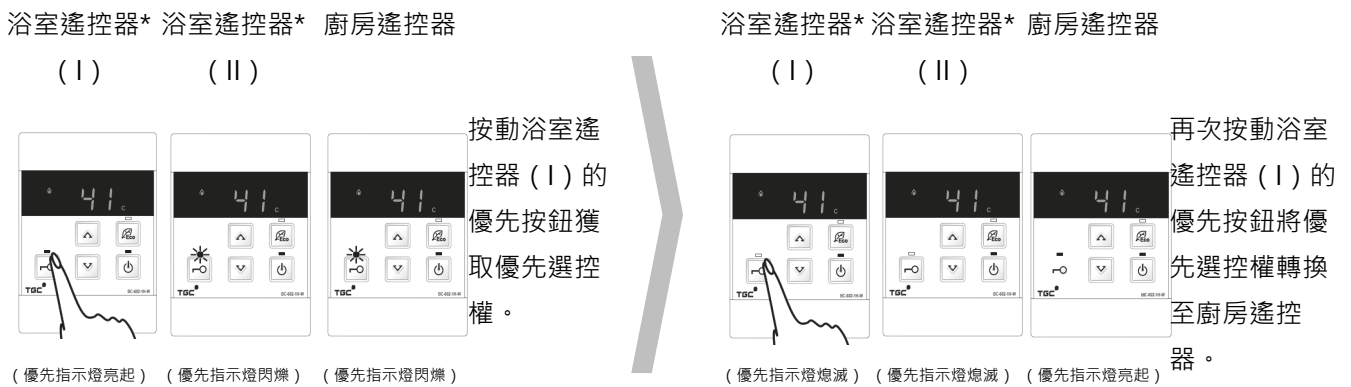

* *TRJW162TFQL* 及 *TRJW222TFQL* : 浴室遙控器 (I) 及浴室遙控器 (II) 為 *BC-602Q-1H* 。
TRJW162TFL 及 *TRJW222TFL* : 浴室遙控器 (I) 及浴室遙控器 (II) 為 *BC-602-1H* 。
 廚房遙控器為 *MC-602-1H* 。

啟動預熱循環功能

此功能只適用於 TRJW162TFQL 及 TRJW222TFQL 型號，並需配合浴室遙控器一併使用。遙控器型號為 BC-602Q-1H。預熱循環功能會自動將冷水加熱及維持至設定的預熱循環水溫，於開啟熱水水龍頭時便立刻可使用所需溫度的熱水。



- 啟動預熱循環功能後，爐具將連續運作直至再次按預熱循環按鈕關閉功能。功能運作時，由於優先選控權仍能轉換，因此已設定的預熱循環水溫有機會由另一遙控器變更。使用熱水前請先確認遙控器上溫度顯示的設定溫度，或先用手確認水溫，切勿直接將熱水噴灑在頭和身體上，以免燙傷。
- 預熱循環水溫不會因優先選控權的轉換至廚房遙控器而變更。因此當優先選控權被轉換至廚房遙控器時，預熱循環水溫仍會按照先前擁有優先選控權的浴室遙控器所設定的溫度運作。
- 使用高溫熱水後，水管中仍存有高溫熱水。再次使用較低溫的熱水時，應先用手確認水溫，待溫度適合後才使用。

(1) 啟動爐具

- 啟動爐具電源後，按遙控器上的開/關按鈕。
- 溫度顯示及運作指示燈亮起，此時爐具處於備用狀態。
- 用作啟動爐具的遙控器即擁有優先選擇權，優先指示燈會亮起。當優先指示燈閃爍時，優先選控權不能轉換。

(2) 設定預熱循環水溫

- 利用擁有優先選擇權的遙控器可調節預熱循環水溫。

調高熱水水溫	調低熱水水溫
最高水溫設定：50°C	最低水溫設定：35°C
熱水水溫可調節範圍	
35 37 38 39 40 41 42 43 44 45 46 47 48 50	

- 35°C為最低預熱循環水溫，而50°C則為最高預熱循環水溫。即使設定為50°C以上，最高預熱循環水溫亦只有50°C。
- 所設定的預熱循環溫度會同時顯示於所有遙控器的溫度顯示上。
- 預熱循環溫度設定為50°C或以上時，高溫指示燈會亮起。

(3) 啟動預熱循環功能

- 按擁有優先選擇權的遙控器上的預熱循環按鈕啟動功能，預熱循環指示燈亮起。爐具自動將冷水加熱至設定預熱循環水溫。
- 再次按遙控器上的預熱循環按鈕取消功能，預熱循環指示燈熄滅。

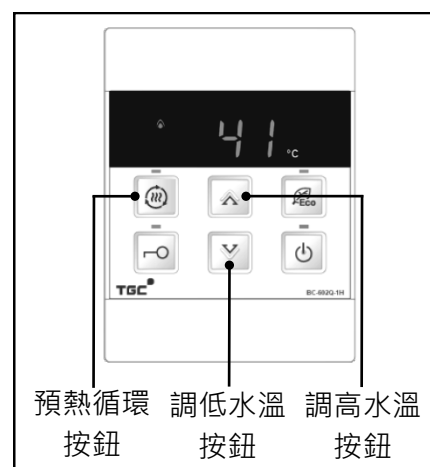
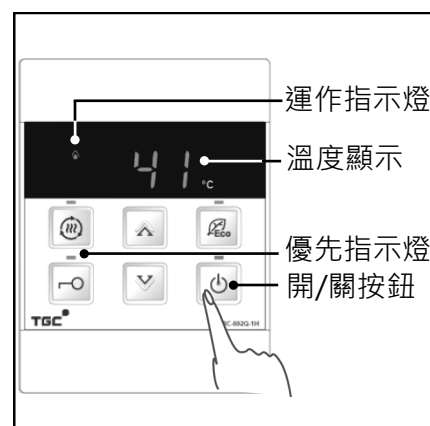

操作指示

供水暫停提示及處理

此提示及處理方法只適用於 TRJW162TFQL 及 TRJW222TFQL 型號。

(1) 暫停供水時

- 切勿開啟熱水水龍頭，以免空氣進入水管。

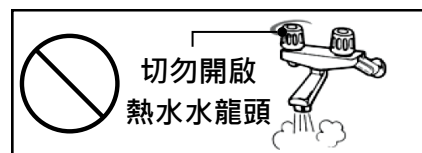

(2) 供水恢復後

- 按遙控器上的開/關按鈕關閉爐具，將距離爐具最遠的熱水水龍頭完全開啟 1 分鐘。
- 如空氣未有從熱水水龍頭內排出，關閉熱水水龍頭。將熱水水溫設定於 50°C，啟動爐具及預熱循環功能，並運作 3 分鐘。
- 如預熱循環功能未有出現問題，便可關閉爐具。
- 重新啟動爐具並將熱水水溫設定於 40°C，並完全開啟熱水水龍頭 1 分鐘。

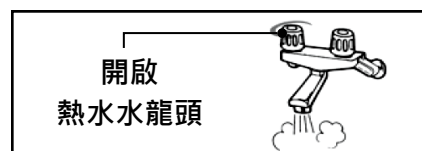

(3) 供水恢復後，於再啟動預熱循環功能時出現故障信號

- 於再啟動預熱循環功能時，故障信號「63」有機會閃爍於溫度顯示上。

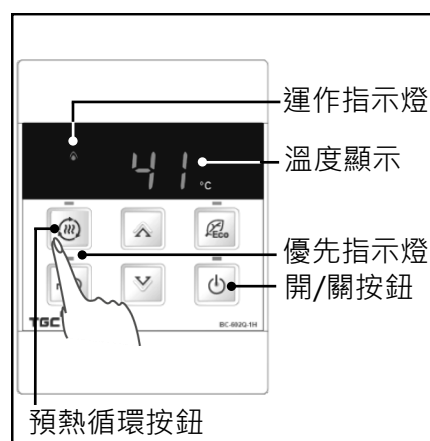

(3A) 再啟動預熱循環功能

- 如水管內仍殘留空氣，按遙控器上的開/關按鈕關閉爐具。
- 按遙控器上的開/關按鈕，啟動爐具及預熱循環功能，並運作一段時間。
- 重覆以上操作至故障信號「63」消除。
- 故障信號消除後，便可關閉爐具。
- 重新啟動爐具並將熱水水溫設定於 40°C，並完全開啟熱水水龍頭 1 分鐘。

(3B) 如故障信號仍然維持，按以下指示處理

- 按遙控器上的開/關按鈕關閉爐具，將距離爐具最遠的熱水水龍頭完全開啟，排出水管內殘留空氣。
- 鬆開預熱循環回流接口的排水閥，並將空氣從排水管排出。完全排出空氣後，將排水閥重新擰緊。
- 按遙控器上的開/關按鈕，啟動爐具及預熱循環功能，並運作一段時間。
- 故障信號消除後，便可關閉爐具。
- 重新啟動爐具並將熱水水溫設定於 40°C，並完全開啟熱水水龍頭 1 分鐘。

操作指示

安全裝置

- **熄火安全裝置**：裝置利用火焰感應棒監察燃燒狀態是否正常。當火焰失效時，信號會傳送到主控器，裝置會啟動，並停止爐具運作。
- **殘火保護裝置**：熱水水龍頭關閉後，若火焰仍然存在而熱交換器內的熱水溫度高達設計溫度時，裝置會啟動，並停止爐具運作。
- **防止過度沸騰保護裝置**：當熱水溫度高於設計溫度時，裝置會啟動，並停止爐具運作。
- **防止過熱保護裝置**：當熱交換器燒毀或溫度高於設計溫度時，裝置會啟動，並停止爐具運作。
- **防止過高水壓保護裝置**：當爐具內的水壓高於設計水壓，位於熱水出口的水洩壓閥會打開洩壓，並於水壓降回設計水壓時關閉。
- **水流量感應裝置**：當冷水水流受到阻隔或被中止，裝置會啟動，並停止爐具運作。
- **助燃風扇轉速檢查裝置**：裝置利用轉速感應器監察風扇的轉速是否正常。當風扇轉速與要求轉速有所偏差時，偏差信號會傳送到主控器以調整轉速。

調節熱水溫度提示

- 為配合在不同季節的沐浴使用，可透過遙控器調節所需的熱水溫度。
- 在冬季偶有極寒冷的天氣，自來水的溫度可能過低或熱水流量過大，爐具的出水溫度可能會比較低，您可以調節水龍頭或花灑掣來減少熱水水流量，以便獲得適合的水溫。
- 在夏季偶有極炎熱的天氣，自來水的溫度可能過高或熱水流量過小，爐具的出水溫度可能會比較高，您可以取消環保 (Eco) 模式，並調節水龍頭或花灑掣輔以混合冷水，以便獲得適合的水溫。

保養

- (1) 爐具機身及遙控器不可用溶劑清潔，應使用濕軟布揩抹，再用乾軟布抹乾。
- (2) 爐具機身及遙控器備有防水設計，但亦盡量避免向機身及遙控器噴水。
- (3) 如花灑出水量變少，花灑頭的水孔可能已堵塞。應檢查並加以清理。
- (4) 必須定期檢查及保養爐具，以確保使用上的安全及效率。

故障處理

安全裝置會持續監察爐具運作的狀況。當故障發生時，故障信號會立即顯示在溫度顯示上。當致電維修服務時，請說出故障時所顯示號碼。

故障信號	故障原因	處理方法
02	60分鐘自動停止運作	關閉熱水水龍頭，10秒後重新開啟熱水水龍頭。
10	進風或排煙異常	請致電客戶服務。
11	仍未開啟煤氣錶閥及 / 或爐具供氣閥	完全開啟煤氣錶閥及 / 或爐具供氣閥。
	喉管內含有空氣	關閉熱水水龍頭，10秒後重新開啟熱水水龍頭。
	點火失誤	關閉遙控器後，檢查煤氣錶閥及 / 或爐具供氣閥是否完全開啟。確認供氣正常及未有中斷。如供氣正常，重新啟動遙控器。重複開啟及關閉熱水水龍頭數次，每次開關需隔約10秒。如故障信號仍然存在，請致電客戶服務。
12	中途熄火保護裝置啟動	請致電客戶服務。
14	殘火保護裝置啟動	請致電客戶服務。
16	防止過熱保護裝置啟動	請致電客戶服務。
31	回水溫度感應裝置異常或故障	請致電客戶服務。
32	出水溫度感應裝置異常或故障	請致電客戶服務。
33	熱交換器溫度感應裝置異常或故障	請致電客戶服務。
34	進風溫度感應裝置異常或故障	請致電客戶服務。
52	燃氣調節閥線路異常	請致電客戶服務。
61	助燃風扇異常	請致電客戶服務。
63	預熱循環系統異常 (只TRJW162TFQL及TRJW222TFQL適用)	關閉並重新啟動遙控器後，重複啟動預熱循環功能數次。如故障信號仍然存在，請致電客戶服務。
70	電控部分異常或故障	請致電客戶服務。
71	電控部分異常或故障	請致電客戶服務。
72	電控部分異常或故障	請致電客戶服務。

在一般情況下，關閉熱水水龍頭然後重新開啟，故障信號有可能消除。若故障信號仍然存在，可先嘗試關閉供電電源，等待 10 秒後重新啟動爐具。如故障信號繼續存在，請致電客戶服務熱線 2880 6988。

在寒冷及潮濕的天氣，排煙管出口偶會冒出煙霧，這是煙氣中的水氣遇冷而形成白色煙霧，此屬正常現象。

關於熱水供應及溫度

沒有熱水供應

- 檢查供氣是否正常及有否出現中斷。
- 檢查水龍頭是否出水正常。
- 檢查冷水過濾網是否被堵塞。
- 檢查供電是否正常。
- 完全開啟煤氣錶閥及 / 或爐具供氣閥。
- 完全開啟冷水水掣及 / 或熱水水龍頭。
- 啟動爐具電源後，並按遙控器上的開/關按鈕。

熱水沒有即時流出

- 啟動電源後，按遙控器上的開/關按鈕。
- 未有啟動預熱循環功能（所有型號適用）
從爐具到熱水水龍頭間存在一段距離，因此熱水未能即時流出。
- 已啟動預熱循環功能（只適用於TRJW162TFQL及TRJW222TFQL型號）
從啟動功能到達到設定的預熱循環水溫需時間加熱，因此熱水未能即時流出。

熱水流量出現變化

- 如爐具正於一個水龍頭供應熱水，並於另一個水龍頭需同時供應熱水時，熱水水流量會減少。而因應供水水壓及水管狀況，有機會出現熱水水流量驟降或水流斷續的情況。待供水水壓及水管狀況穩定後，熱水水流會穩定下來。
- 因不同水龍頭產品於特性上有所差異，熱水水流量的改變有機會屬個別產品的特性。例如：熱水水流於剛流出時會較多，後續水流將趨於穩定。

熱水溫度過高

- 完全開啟冷水水掣及 / 或熱水水龍頭。
- 檢查所設定的熱水溫度是否適當。
- 在夏季偶有極炎熱的天氣，自來水的溫度可能過高或熱水流量過小，爐具的出水溫度可能會比較高，您可以調節水龍頭或花灑掣輔以混合冷水，以便獲得適合的水溫。

熱水溫度過低

- 完全開啟煤氣錶閥及 / 或爐具供氣閥。
- 檢查所設定的熱水溫度是否適當。
- 在冬季偶有極寒冷的天氣，自來水的溫度可能過低或熱水流量過大，爐具的出水溫度可能會比較低，您可以調節水龍頭或花灑掣來減少熱水水流量，以便獲得適合的水溫。

關於熱水供應及溫度

熱水溫度不穩定

- 完全開啟供水主閥，確保供水壓力足夠。
- 增加混合水龍頭的熱水量，避免因熱水流量低於最低熱水流量，而導致燃燒器關閉。

不能調節熱水溫度設定

- 確認使用的遙控器擁有優先選擇權，檢查優先指示燈是否亮起。
- 爐具運作時，熱水溫度只可設定為 48°C 或以下。如熱水溫度已設定為 50°C 或以上，熱水溫度只可調低。

關於遙控器及爐具運作

運作指示燈沒有亮起

- 檢查供電是否正常。
- 啟動爐具電源後，並按遙控器上的開/關按鈕。

熱水溫度設定自行變更

- 設定溫度為 50°C 或以上，且處於備用狀態超過 10分鐘時，優先選控權會自動解除，設定溫度將變更為 48°C。
- 設定溫度為 50°C或以上時，解除後再取回優先選控權時 (如適用)，溫度設定將變更為 48°C。

沒有使用熱水，但風扇及水泵仍然運作

- 燃燒器關閉後，助燃風扇仍維持短暫運作，此屬正常運作。
- 預熱循環功能運作中。

使用中途熄火

- 完全開啟煤氣錶閥及 / 或爐具供氣閥。
- 檢查供氣是否正常。
- 完全開啟冷水水掣及 / 或熱水水龍頭。
- 檢查水龍頭是否出水正常。

排煙管出口冒出煙霧

- 在寒冷及潮濕的天氣，煙氣中的水氣遇冷形成白色煙霧，此屬正常現象。

熱水出水變為白色並出現渾濁情況

- 水中溶解的空氣受熱後，形成氣泡，此屬正常運作。

偶然於水洩壓閥出口短暫流出水份

- 爐具內水壓高於設計水壓，位於熱水出口的水洩壓閥會打開洩壓，並於水壓降回設計水壓時關閉。

規格

型號		TRJW222TFQL	TRJW162TFQL	TRJW222TFL	TRJW162TFL	
基本規格	爐具類別	機動排煙密封式				
	安裝方式	獨立式 / 懸掛式				
	排氣方式	頂排式				
	機身尺寸 - 闊 x 高 x 深 (毫米)	453 x 370 x 280				
	重量 (千克)	24		20.5		
	燃氣種類	香港煤氣				
	供氣壓力 (千帕)	1.5				
	燃氣接駁	3/4 吋英制螺紋				
	水管接駁 (毫米)	冷水	3/4 吋英制螺紋			
		熱水	3/4 吋英制螺紋			
		預熱循環	1/2 吋英制螺紋		/	
		預熱循環水長度	最長60米 (出水: Ø25 / 回水: Ø15)		/	
	供電及信號接駁	電源	220 伏特 / 50 赫茲			
		信號線	直流 12 伏特 (雙芯線)			
	排氣接駁 (毫米)	排氣管出口	圓形 / 百葉式			
		排氣管直徑	進風接口: Ø125 / 排氣接口: Ø80			
		排氣管長度	最長 7 米及 1 個彎位 (1 個彎位約等於 2 米長度)			
點火方式	自動電子點火					
額定熱負荷 (千瓦)	最高	48.0	39.3	48.0	39.3	
	最低	2.5		4.4		
耗電量 (瓦)	104		76			
	預熱循環泵: 30					
防水能力	機身	IPX2				
	遙控器	IPX5				
系統運作	熱水供應量 25°C 升溫 (公升/分鐘)	2.7 至 22.0	2.7 至 18.0	2.7 至 22.0	2.7 至 18.0	
	熱水供應量範圍 (公升/分鐘)	2.7 至 24.0	2.7 至 20.0	2.7 至 24.0	2.7 至 20.0	
	最低熱水流量 (公升/分鐘)	2.7				
	最低運作水壓 (千帕)	10				
	建議運作水壓範圍 (千帕)	150 至 500				
	熱水水溫選擇 (°C)	35、37 至 48、50、55 及 60 (預熱: 最高 50°C)				
安全裝置	熄火安全裝置	火焰感應棒				
	殘火保護裝置	雙金屬開關 (97°C)				
	防止過度沸騰保護裝置	熱敏電阻 (95°C)				
	防止過熱保護裝置	溫度保險絲 (129°C)				
	防止過高水壓保護裝置	水洩壓閥 (啟動水壓: 1000 千帕) (關閉水壓: 700 千帕)		水洩壓閥 (啟動水壓: 2100 千帕) (關閉水壓: 1500 千帕)		
	水流量感應裝置	水流感應器				
	助燃風扇轉速檢查裝置	轉速感應器				
	電流過大保護裝置	保險絲 (5A)				
功能	環保 (ECO) 模式	有				
	智慧功能	可加購外置控制器 (WiFi)				
配件	遙控器 (※可供選購)	BC-602Q-1H (※BC-602Q-1H / MC-602-1H)		BC-602-1H (※BC-602-1H / MC-602-1H)		
	供水減壓閥出口壓力	500 千帕 (適合供水壓力高於 500 千帕)		/		

爐具符合香港電氣產品(安全)規例。

Contents



Important Safety Instructions	P. 1
Product Descriptions	P. 5
Operating Instructions	P. 8
Maintenance	P. 14
Troubleshooting	P. 15
Specifications	P. 18

Attention!

According to the Gas Safety Ordinance of Hong Kong, any gas installation works including the installation of appliances and connection tubing, must be undertaken by registered gas installers who are registered for that appropriate classes and be employed by registered gas contractor.

Important Safety Instructions





In order to use this appliance safely, please be sure to follow the below guidelines. The following guidelines have an important bearing on safety. Symbols and their meanings are as below.

 Danger	If you ignore this warning sign and act mistakenly, it may incur death, or serious injury and will lead to an imminent danger of fire breaking out.
 Warning	If you ignore this warning sign and mistakenly handle the appliance, it may incur death or serious injury and may lead to fire incident.
 Caution	If you ignore this warning sign and mistakenly handle the appliance, this may incur injury or property damage.

The above injuries and properties damage refer specifically to the following descriptions.

- Injury: injuries, burns and electric shocks etc. that require treatment in hospital or long-term hospitalization.
- Properties Damage: widespread damage to house and furnishings.

In this user instructions includes different symbols, please refer to the following descriptions for the meanings of corresponding symbols.

					
Danger, warning, caution	Forbidden	Do not touch	Be sure to do	Disassembly is forbidden	Must be earthed

Danger

If you notice following problems with this appliance



- If you notice abnormal flames, gas smell or strange sounds when using the appliance, please turn off hot water tap and gas meter valve immediately and contact customer service.
- In the event of earthquake or fire, cease operation without hesitation.

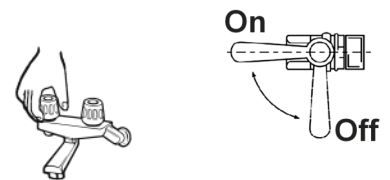

1. Turn off hot water tap
2. Turn off gas meter valve



Do not place the outlet of flue terminal indoor

- The outlet of flue terminal should be faced outdoor.

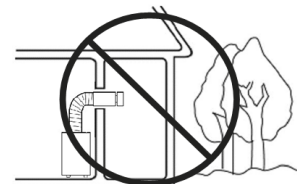

Important Safety Instructions

Danger



If you notice a gas leak

1. Cease use and turn off the gas meter valve.

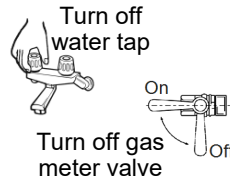

2. Open all windows to disperse the gas.



3. Call Towngas Emergency Hotline on 2880 6999 with a phone outside the premises.



If there is a gas leak

- Do not ignite a fire, insert or remove power plug.
- Turning on or off any electrical appliance is forbidden.
- Do not use nearby telephone or mobile phone.



When there is a gas leak, do not perform any of the above actions until repair work has been completed.

Do not perform any of the above actions or turn on the gas meter valve again until the gas is no longer leaking.

Warning

Care to be taken with children



- When filling hot water into the bath-tub, do not allow children to play in the bathroom to avoid the children falling into the bath-tub or causing any dangers.
- Do not allow children to bath without the supervision of adult.

Self disassembling, repairing and modification of appliance are strictly forbidden



- Gas installer, who performs any installation, maintenance and its related work of appliance, shall be employed by registered gas contractor and be registered under appropriate class of gas installation work to prevent hazard or damage of appliance.

Do not cover outlet of flue terminal



- Do not place the outlet of flue terminal in an indoor environment due to additions or reconstruction in order to avoid the occurrence of carbon monoxide poisoning or fire hazard.

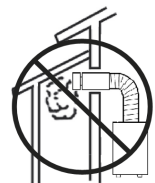

Important Safety Instructions



Caution

Regarding installation

- Do not install the appliance at outdoor.
- Install and use the gas appliance in a well-ventilated room.
- If the gas appliance is installed in compartment, the minimum compartment requirement should follow the requirement in Code of Practice GU03 from EMSD.
- Minimize pipe length and avoid dead legs and stagnant corners in hot water pipework.
- Minimize the distance between hot water outlet and water tap.
- When installing the flue terminal, make sure the flue gas does not discharge directly to the outside walls, windows, glass, mesh doors or aluminum sashes etc. This could cause material disfiguration or discolouration.



- Keep things away from the appliance to the distance as shown in the figure.

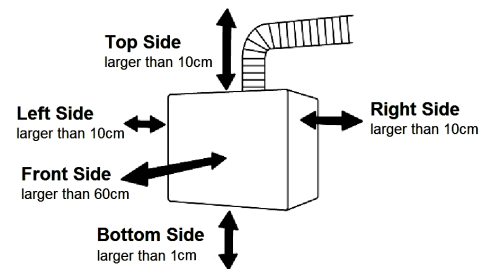

What you must do to prevent fire

- Do not place flammable materials, such as paper, wood or clothes, around the appliance or flue terminal.
- Do not place or use volatile materials, such as gasoline or benzene, around the appliance or flue terminal.
- Do not place or use spray cans, such as hair spray or spray cleaners, around the appliance or flue terminal.



Flue Terminal

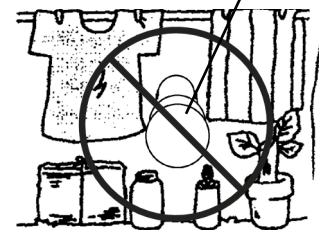

Regarding use

- This appliance is intended for residential application only. Do not use it for commercial application lest its service life is shortened.
- Do not use water from the appliance for drinking or cooking.
- This appliance is intended for supplying hot water to bathroom and kitchen. Do not use it for other purpose in order to avoid incident or damage of appliance.



What you must do to prevent scalding

- When turning on the tap again after using hot water or quickly reducing the hot water flow, relatively high-temperature hot water may suddenly come out. As there is a risk of being scalded, do not direct the hot water onto your head or body.
- When using the shower, relatively high-temperature hot water may come out first. In order to prevent scalding, check the hot water temperature with hand first. Do not direct the hot water onto the head or body.



Check hot water temperature with hand first



- Do not touch the flue terminal to prevent from scalding.



Do not touch flue terminal

Important Safety Instructions



Caution



Regarding control unit of appliance

- Keep the remote control out of reach of children. It is intended to prevent accidents or damage of appliance.

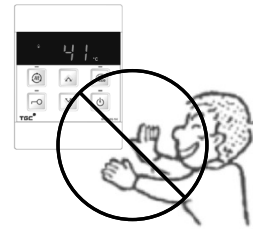

Regarding operation

- If appliance is not used for more than one week, drain away stagnant water inside the water pipework before use.
- During water purging, generation of water mist or splash should be avoided.
- Method of water purging (points ii and iii are only applicable to models with pre-heat circulation function)
 - i) Turn off the appliance, fully turn on the most distant hot water tap from the appliance for 1 minute.
 - ii) Turn off the hot water tap and set the hot water temperature to 50°C. Turn on the appliance with the activation of pre-heat circulation function for 3 minutes.
 - iii) Set the hot water temperature to 40°C and fully turn on the hot water tap for 1 minute.
- To save energy and prevent cultivation of bacteria, do not activate the pre-heat circulation function for long period of time without hot water usage. Switch off appliance completely when hot water is not used.



Regarding cleaning and maintenance

- If the appliance or pipework circuits are in contact with chlorine-based fungicides, acidic bathroom cleaners, deodorants or salt, wash them off with ample water straight away to prevent causing accidents or damage of appliance.
- Do not use solvent or oil-based cleaners to clean the appliance. This could cause discolouration or disfiguration of appliance.
- Use only genuine parts for this appliance to prevent causing accidents or damage of appliance.



Product Descriptions

TRJW162TFQL / TRJW222TFQL

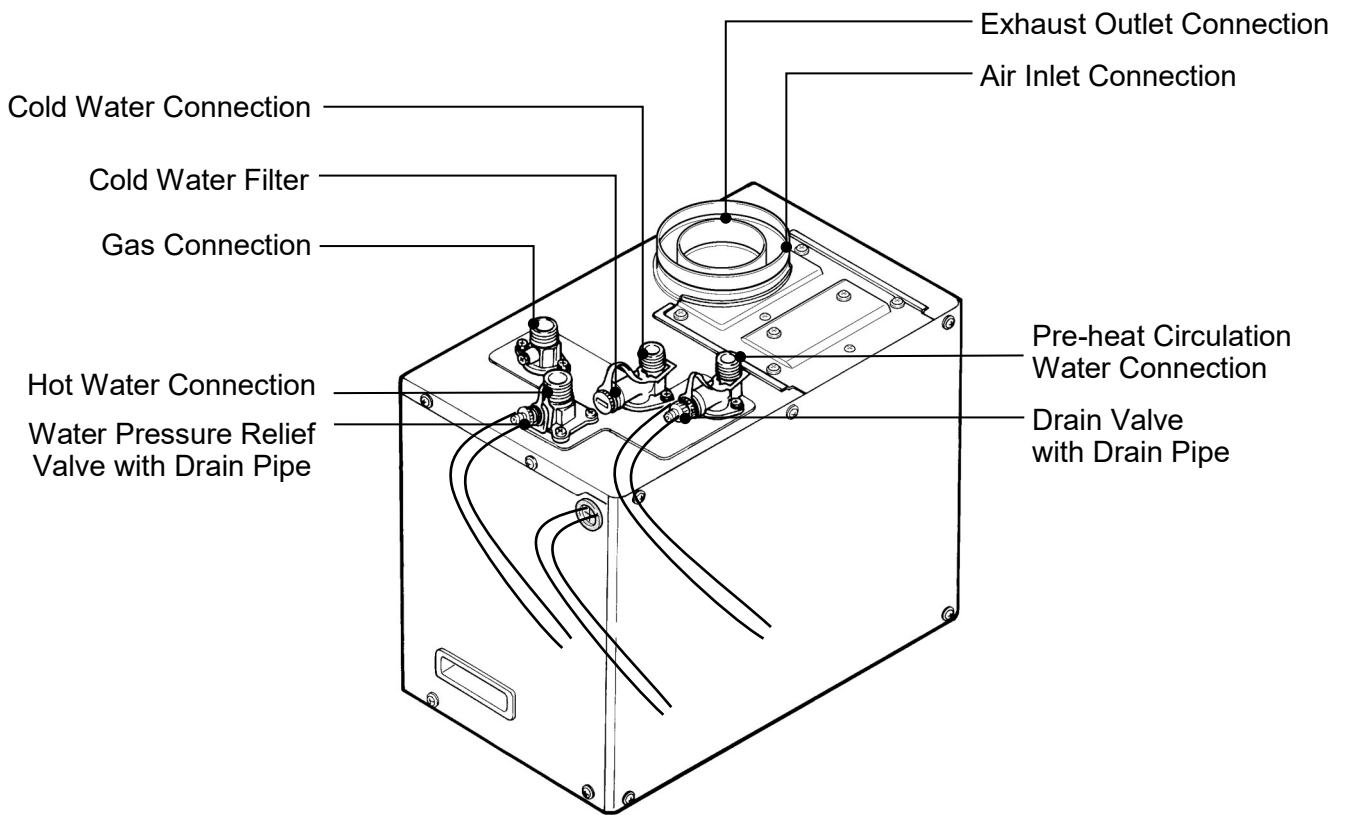

TRJW162TFL / TRJW222TFL

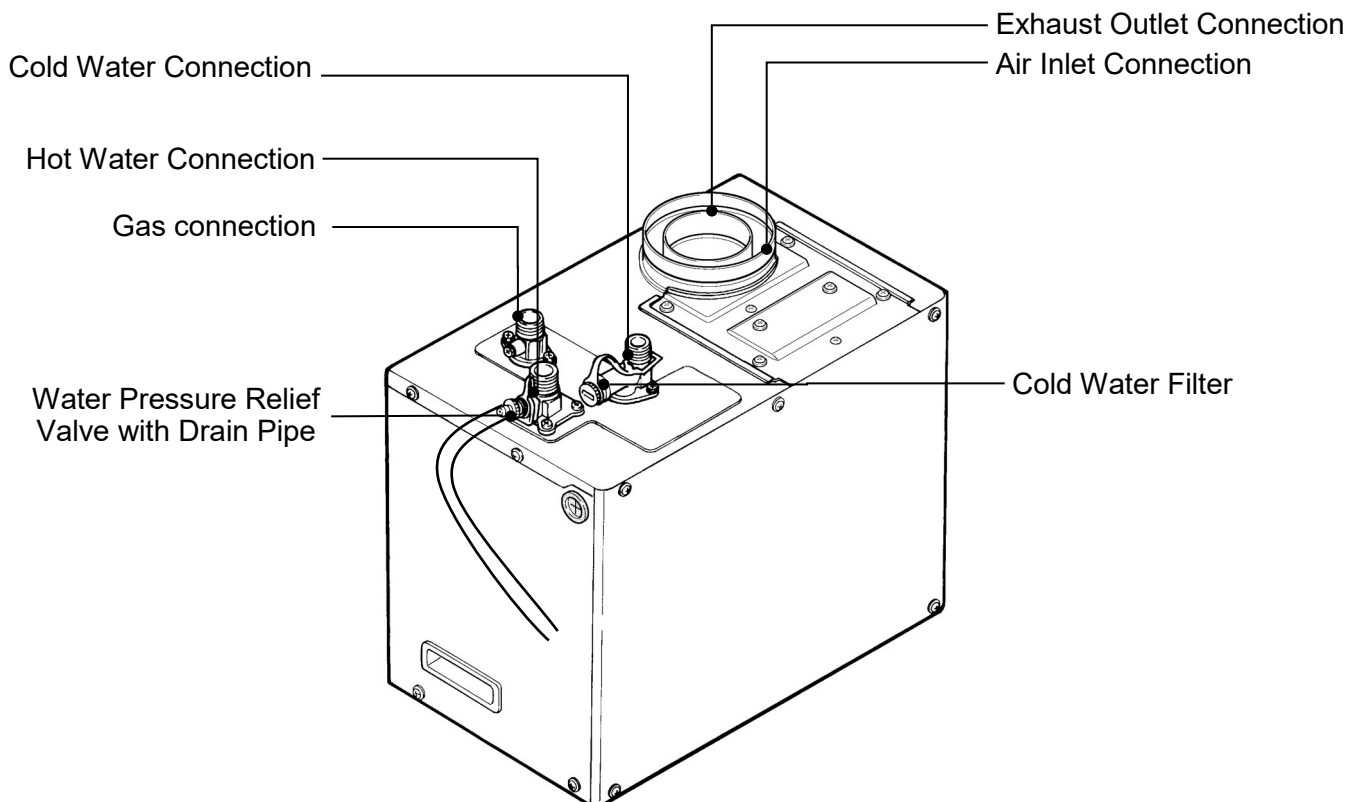

Product Descriptions

Remote Control

TRJW162TFQL / TRJW222TFQL Remote Control Connection

- Appliance comes with 1 bathroom remote control (BC-602Q-1H).
- Additional remote controls can be purchased optionally. Maximum 3 remote controls can be connected with the appliance.
- 1 bathroom remote control (BC-602Q-1H) should be connected when appliance is connected with 2 remote controls. The other remote control could be 1 bathroom remote control (BC-602Q-1H) or 1 kitchen remote control (MC-602-1H).
- 2 bathroom remote control (BC-602Q-1H) and 1 kitchen remote control (MC-602-1H) should be connected when appliance is connected with 3 remote controls.

Bathroom Remote Control

BC-602Q-1H



(with appliance)

Bathroom Remote Control

BC-602Q-1H



(optional to purchase)

Kitchen Remote Control

MC-602-1H

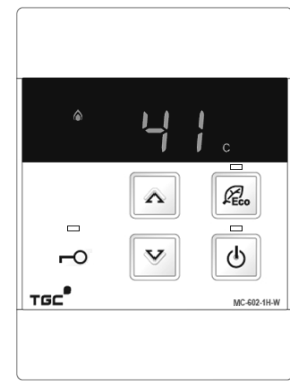

(optional to purchase)

TRJW162TFL / TRJW222TFL Remote Control Connection

- Appliance comes with 1 bathroom remote control (BC-602-1H).
- Additional remote controls can be purchased optionally. Maximum 3 remote controls can be connected with the appliance.
- 1 bathroom remote control (BC-602-1H) should be connected when appliance is connected with 2 remote controls. The other remote control could be 1 bathroom remote control (BC-602-1H) or 1 kitchen remote control (MC-602-1H).
- 2 bathroom remote control (BC-602-1H) and 1 kitchen remote control (MC-602-1H) should be connected when appliance is connected with 3 remote controls.

Bathroom Remote Control

BC-602-1H



(with appliance)

Bathroom Remote Control

BC-602-1H

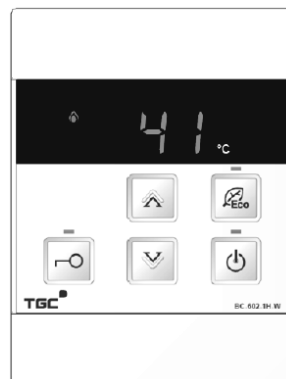

(optional to purchase)

Kitchen Remote Control

MC-602-1H

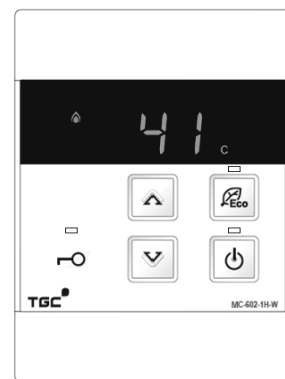

(optional to purchase)

Product Descriptions

Remote Control

Operation Indicator

- Orange indicator lights up during operation.

Pre-heat Circulation Button & Indicator

- Use for activating pre-heat circulation function.
- Press the button to activate function. Green indicator lights up.
- Remote control with priority can set the pre-heat circulation temperature. Maximum is 50°C.
- When priority is changed to kitchen remote control, pre-heat circulation temperature setting will be same as the previous bathroom remote control with priority. Maximum is 50°C.

Priority Button / Priority Indicator

Bathroom Remote Control

- Use for changing priority of front panel control or remote control.
- Press the button to obtain the priority. Green indicator lights up on the remote control with priority.
- Front panel control or remote control with priority indicator lighting up can adjust hot water temperature.
- Priority cannot be changed when the indicator flashes.
- Press it again to obtain the priority when indicator goes out.

Kitchen Remote Control

- Priority Indicator Only.
- Green indicator lights up on the remote control with priority.

Temperature Display

- Display setting of hot water temperature.
- Error code will be displayed when the appliance malfunctions.
- Temperature display blinks when hot water temperature is set at or above 50°C.

Eco Button & Indicator

- Press the button to turn on Eco mode, green indicator lights up.

Water Temperature Setting Button

- Use for adjusting hot water temperature.

ON/OFF Button & Indicator

- Use for turning on or off appliance.
- Press the button to turn on appliance, temperature display, ON/OFF indicator and green priority indicator light up.
- Press the button to turn off appliance when priority indicator lights up.

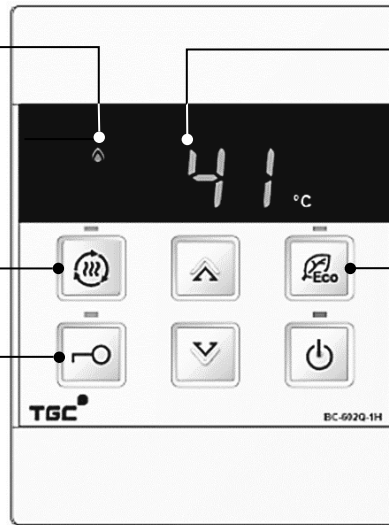

Bathroom Remote Control :

BC-602Q-1H

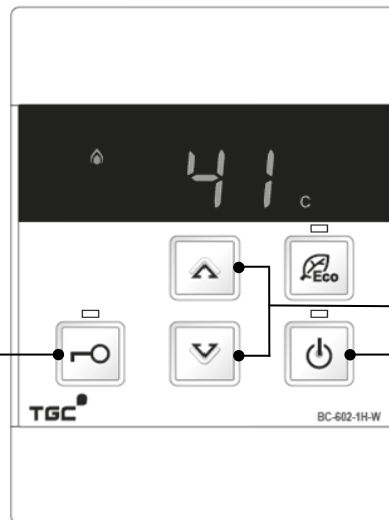

Bathroom Remote Control :

BC-602-1H

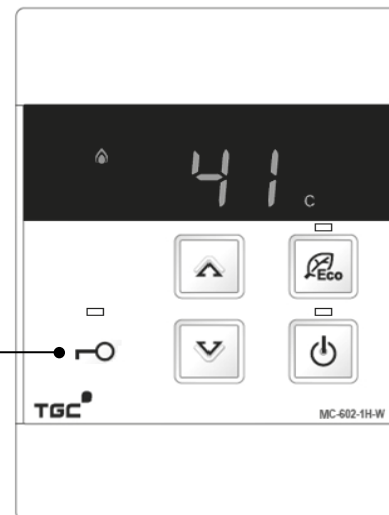

Kitchen Remote Control :

MC-602-1H

Operating Instructions

Caution

- When using the appliance for the first time or in the morning, the burner may not be ignited instantly because there may be some air remained inside the gas pipe. Please turn off the hot water tap and wait for 10 seconds, then turn on the hot water tap again to repeat the auto-ignition process.
- To prevent scalding:
 - check hot water temperature with hand first before taking shower. Do not direct hot water onto the head or body directly.
 - after using high-temperature hot water, the high-temperature hot water still remains inside the water pipework. To use relatively low-temperature hot water again, check the temperature with hand first and wait for suitable temperature before use.
- High temperature indicator lights up, when hot water temperature is set at 50°C or above. Be careful of using high-temperature hot water.
- In case of high water supply pressure, relatively loud sound of water flow may occur during the operation of appliance. This is a normal phenomenon.
- Turn off the cold water valve and the gas supply valve of appliance when it is not used for a long period of time.



Check hot water temperature with hand first

First Time Usage of Appliance

Check the appliance by following instructions.

Set the hot water temperature to 35°C. Fully turn on the hot water tap and turn off after confirming the hot water is running out.

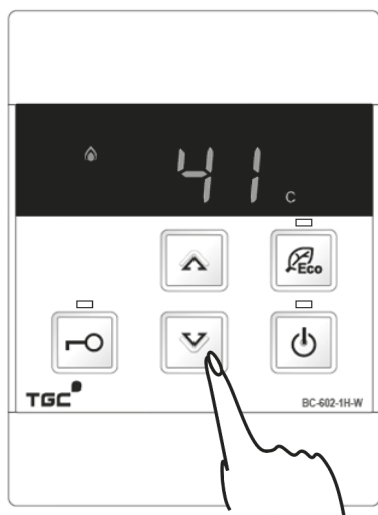

TRJW162TFQL
TRJW222TFQL

TRJW162TFL
TRJW222TFL

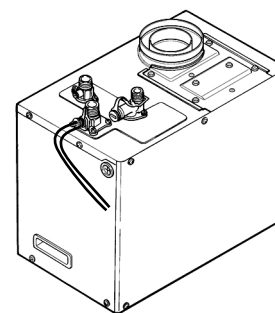
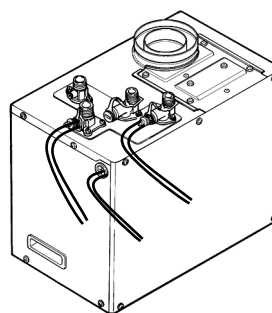

Operating Instructions

Use of Appliance

(1) Starting up appliance

- After turning on the power supply of appliance, press the ON/OFF button on front panel control/remote control.
- Temperature display and ON/OFF indicator light up. Appliance is under standby mode.
- Front panel control/remote control use for turning on appliance has the priority, and its priority indicator lights up. Priority cannot be changed when the priority indicator flashes.
- First time usage after new installation, default hot water temperature is 42°C.

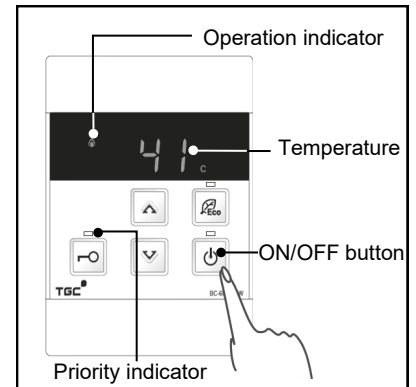

(2) Setting hot water temperature

- Use front panel control/remote control with priority to adjust hot water temperature.

Increase hot water temperature 	Decrease hot water temperature
Highest water temperature setting: 60°C	Lowest water temperature setting: 35°C
Range of adjustment of hot water temperature	
35 37 38 39 40 41 42 43 44 45 46 47 48 50 55 60	

- Temperature display blinks when hot water temperature is set at 50°C or above.

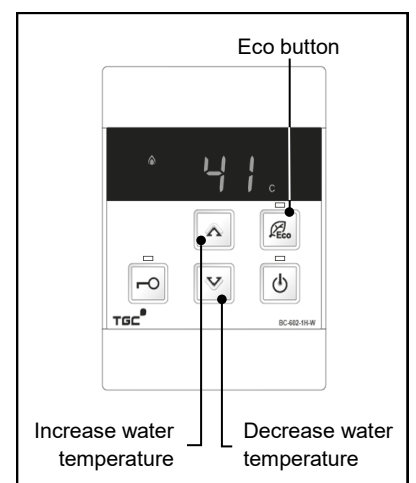

(3) Using hot water

- After turning on hot water tap, burner will be ignited automatically and hot water will be supplied. Orange operation indicator lights up.
- Burner will be turned off when the hot water flow is lower than the minimum hot water flow. Therefore, hot water tap should not be turned on insufficiently. Otherwise, ignition may fail or the flame may be extinguished during use.
- When appliance is in operation, hot water temperature can only be set at 48°C or below. If hot water temperature is set at 50°C or above, hot water temperature can only be decreased.

(4) Setting Eco mode

- Press Eco button to activate Eco mode and its indicator lights up.
- Appliance limits the maximum water flow rate to 9L/min under Eco mode.
- Set temperature will not be affected during the activation of Eco mode.
- Press again the Eco button to deactivate the mode and its indicator goes out.

(5) Stopping use of hot water

- Appliance stops operation immediately and hot water flow stops when the hot water tap is turned off. Operation indicator will go out.
- To use hot water again, repeat step (1) to (4).
- Front panel control or remote control with priority can turn off the appliance. Press the ON/OFF button, all display and indicators go out.

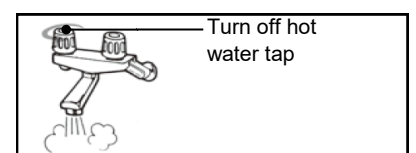
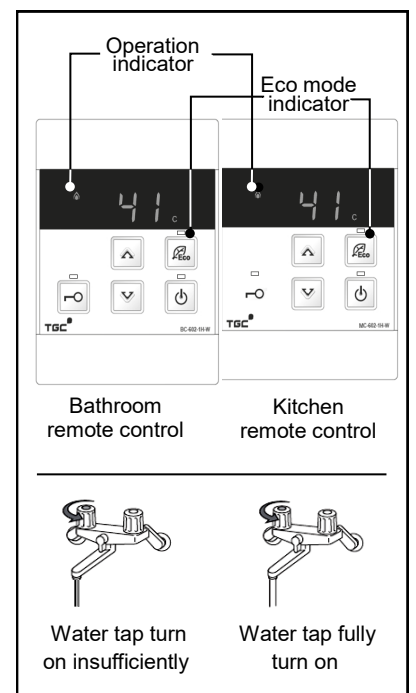

Operating Instructions

Change of Priority (for installation of multiple remote controls)

- When two or more (maximum three) remote controls are installed, only the remote control with priority can adjust the hot water temperature in order to avoid accidents, such as scalding.
- When the bathroom remote control has the priority, its indicator lights up while the others will flash.
- When the kitchen remote control has the priority, its indicator lights up while the others will go out. Press the priority button on the bathroom remote control again to switch back the priority control.
- With the priority, use the bathroom remote control to change the priority to kitchen remote control.
- Each remote control can memorize the previous water temperature setting (maximum 48°C) from the remote control with priority. When the priority is obtained, the previous water temperature setting will be displayed.
- When the appliance is in standby mode for more than 10 minutes, priority will be released. All priority indicators will go out thereafter. When appliance is used again, the appliance will provide hot water at the temperature set by the latest remote control with priority.
- If hot water temperature is set at 50°C or above, water temperature setting will be returned to 48°C when the priority is released.

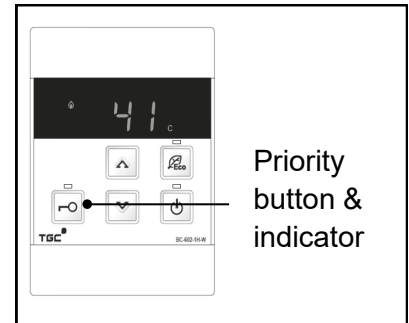

(1) 1 additional bathroom remote control is installed

Bathroom Remote Control* (I)



(Priority indicator lights up)

Bathroom Remote Control* (II)



(Priority indicator is flashing)

Press priority button of bathroom remote control (I) to obtain the priority.

Bathroom Remote Control* (I)

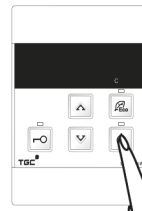

(Remote control turns off)

Bathroom Remote Control* (II)

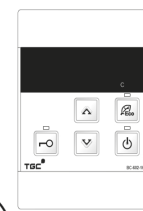

(Remote control turns off)

Press ON / OFF button of bathroom remote control (I) to turn off appliance. Turn on appliance with bathroom remote control (II) to obtain the priority.

Bathroom Remote Control* (I)



(Priority indicator is flashing)

Bathroom Remote Control* (II)



(Priority indicator lights up)

Press priority button of bathroom remote control (II) to obtain the priority.

Bathroom Remote Control* (I)

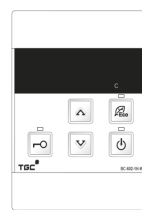

(Remote control turns off)

Bathroom Remote Control* (II)

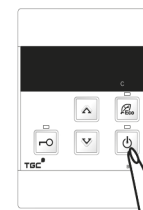

(Remote control turns off)

Press ON / OFF button of bathroom remote control (II) to turn off appliance. Turn on appliance with bathroom remote control (I) to obtain the priority.

* TRJW162TFQL and TRJW222TFQL: Bathroom remote control (I) and bathroom remote control (II) are BC-602Q-1H.
TRJW162TFL and TRJW222TFL: Bathroom remote control (I) and bathroom remote control (II) are BC-602-1H.

Operating Instructions

Change of Priority (for installation of multiple remote controls)

(2) 1 additional kitchen remote control is installed

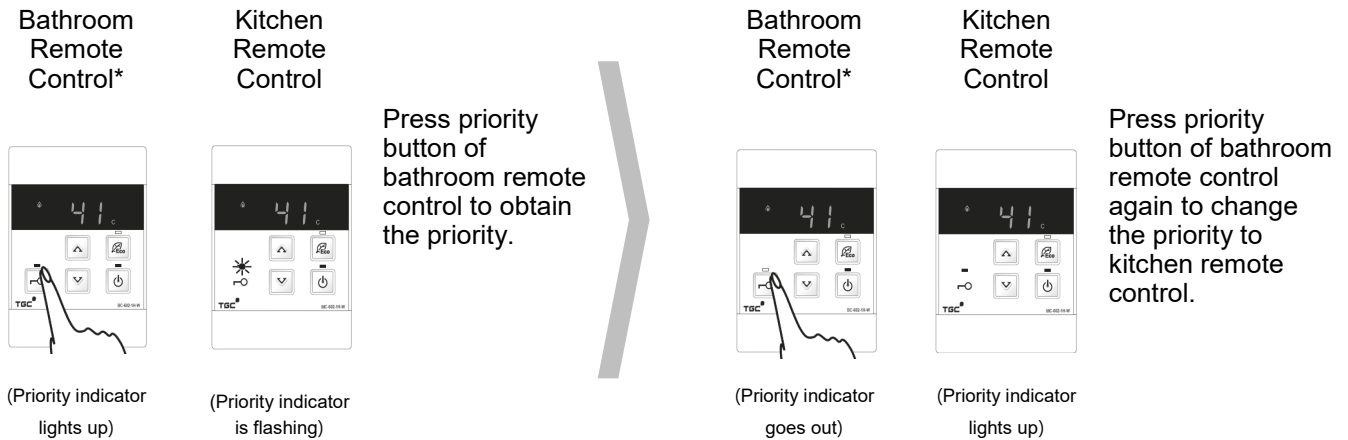

* *TRJW162TFQL and TRJW222TFQL: Bathroom remote control is BC-602Q-1H.
 TRJW162TFL and TRJW222TFL: Bathroom remote control is BC-602-1H.
 Kitchen remote control is MC-602-1H.*

(3) 2 additional remote controls are installed

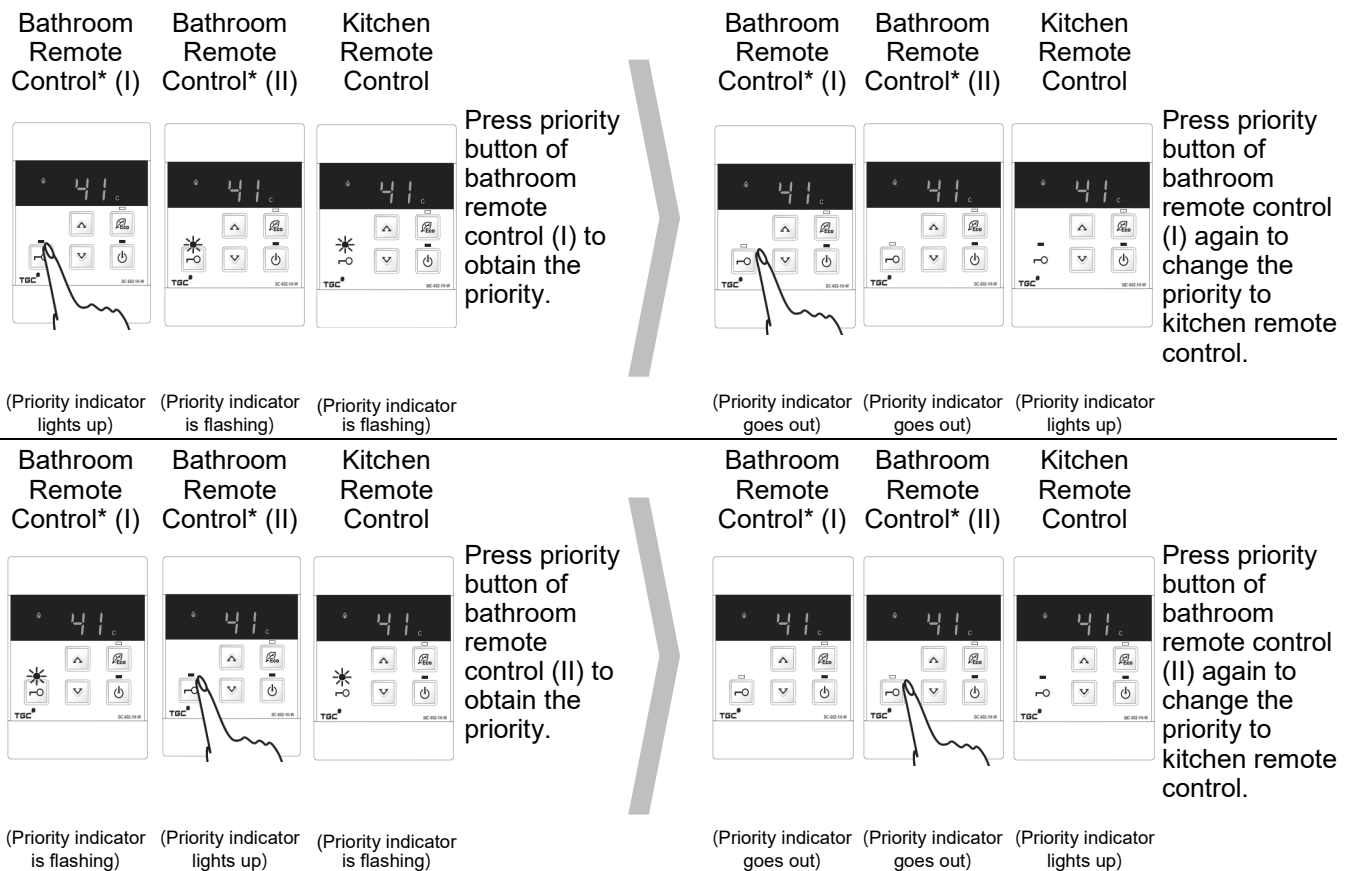

* *TRJW162TFQL and TRJW222TFQL: Bathroom remote control (I) and bathroom remote control (II) are BC-602Q-1H.
 TRJW162TFL and TRJW222TFL: Bathroom remote control (I) and bathroom remote control (II) are BC-602-1H.
 Kitchen remote control is MC-602-1H.*

Operating Instructions

Activation of Pre-heat Circulation Function

This function is only applicable to the models TRJW162TFQL and TRJW222TFQL, and used together with the bathroom remote control. Model of bathroom remote control is BC-602Q-1H. Pre-heat circulation function will automatically heat up the cold water to the set pre-heat circulation water temperature. Preferred hot water temperature is provided immediately once the hot water tap is turned on.



- After activating the pre-heat circulation function, appliance will keep operating until the function is deactivated by pressing the pre-heat circulation button again. Priority can be changed during the operation of pre-heat circulation function, therefore, the pre-heat circulation water temperature may be changed by another remote control. Before using the hot water, check the set temperature on the temperature display of remote control, or check the hot water temperature with hand first. Do not direct hot water onto the head or body directly to avoid scalding.
- Pre-heat circulation water temperature will not be changed by changing the priority to kitchen remote control. Therefore, when the priority is changed to kitchen remote control, the pre-heat circulation water temperature is operated with the temperature set by the latest bathroom remote control with priority.
- After using high-temperature hot water, the high-temperature hot water still remains inside the water pipework. To use relatively low-temperature hot water again, check the temperature with hand first and wait for suitable temperature before use.

(1) Starting up appliance

- After turning on the power supply of appliance, press the ON/OFF button on remote control.
- Temperature display and operation indicator light up. Appliance is under standby mode.
- Remote control use for turning on appliance has the priority, and its priority indicator light up. Priority cannot be changed when the priority indicator flashes.

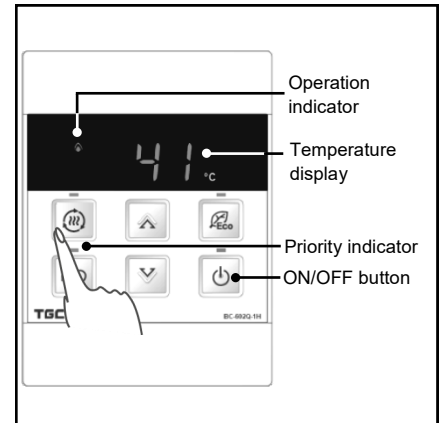

(2) Setting pre-heat circulation water temperature

- Use remote control with priority to adjust pre-heat circulation water temperature.

Increase hot water temperature 	Decrease hot water temperature
Highest water temperature setting: 50°C	Lowest water temperature setting: 35°C
Range of adjustment of hot water temperature 35 37 38 39 40 41 42 43 44 45 46 47 48 50	

- High temperature indicator lights up, when pre-heat circulation water temperature is set at 50°C or above.

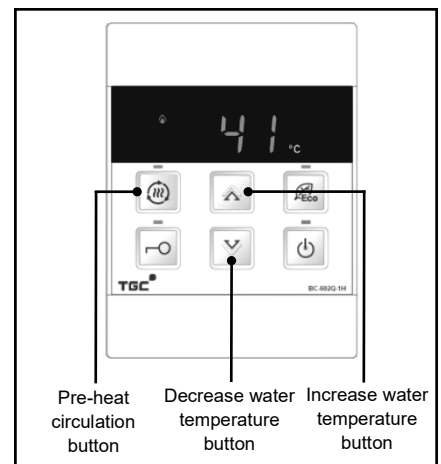

(3) Activating pre-heat circulation function

- Press the pre-heat circulation button on the remote control with priority to activate the function. Pre-heat circulation indicator lights up. Appliance will automatically heat up the cold water to the set pre-heat circulation water temperature.
- Press the pre-heat circulation button on the remote control again to deactivate the function. Pre-heat circulation indicator goes out.

Operating Instructions

Reminder & Handling for Water Suspension

This reminder and handling method are only applicable to the models TRJW162TFQL and TRJW222TFQL.

(1) During suspension of water supply

- Do not turn on the hot water tap to avoid air entering the water pipework.

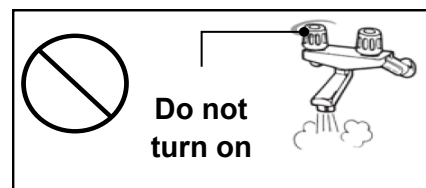

(2) After resumption of water supply

- Press the ON/OFF button on remote control to turn off the appliance. Fully turn on the most distant hot water tap from the appliance for 1 minute.
- If air does not purged from the hot water tap, turn off the hot water tap and set the hot water temperature to 50°C. Turn on the appliance with the activation of pre-heat circulation function for 3 minutes.
- If the pre-heat circulation function is operated without problem, turn off the appliance.
- Turning on the appliance again. Set the hot water temperature to 40°C and fully turn on the hot water tap for 1 minute.

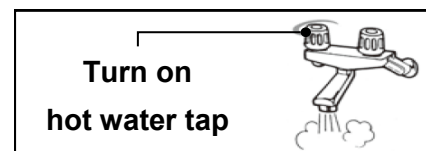

(3) After resumption of water supply, pre-heat circulation function reactivated with error code

- The pre-heat circulation function may be reactivated with an error code "63" flashing on the temperature display.

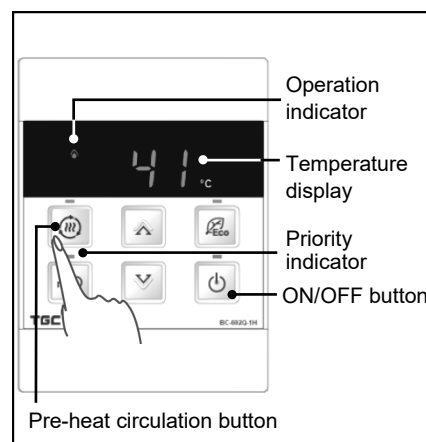

(3A) Reactivating pre-heat circulation function

1. If air is remained in the water pipework, press the ON/OFF button on remote control to turn off the appliance.
2. Press the ON/OFF button on remote control to turn on the appliance with the activation of pre-heat circulation function and operate for some time.
3. Repeat the above operations until the error code "63" is eliminated.
4. If the error code is eliminated, turn off the appliance.
5. Turning on the appliance again. Set the hot water temperature to 40°C and fully turn on the hot water tap for 1 minute.

(3B) If the error code persist, follow the below guidelines

1. Press the ON/OFF button on remote control to turn off the appliance. Fully turn on the most distant hot water tap from the appliance to purge the remained air in water pipework.
2. Loosen the drain valve at pre-heat circulation connection and purge the air from the water pipework. After purging the air, retighten the drain valve.
3. Press the ON/OFF button on remote control to turn on the appliance with the activation of pre-heat circulation function and operate for some time.
4. If the error code is eliminated, turn off the appliance.
5. Turning on the appliance again. Set the hot water temperature to 40°C and fully turn on the hot water tap for 1 minute.

Operating Instructions

Safety Device

- **Flame failure safety device:** Using the flame rod sensor to monitor whether the combustion status is normal. When the flame fails, signal will be sent to the main controller, the device will activate and stop the operation of appliance.
- **Remaining flame protection device:** If the flame still remains with the hot water temperature inside the heat exchanger has reached the design temperature after the hot water tap has been turned off, the device will activate and stop the operation of appliance.
- **Over boiling protection device:** If the hot water temperature is higher than the design temperature, the device will activate and stop the operation of appliance.
- **Over heat protection device:** If the heat exchanger burns out or the temperature reaches the design temperature, the device will activate and stop the operation of appliance.
- **Over pressure protection device:** If the water pressure inside the appliance is over the design pressure value, the pressure relief valve located near the hot water outlet will be opened to release pressure. After reducing to the design pressure value, it will then be closed.
- **Water flow sensing device:** If the cold water flow becomes restricted or stop, the device will activate and stop the operation of appliance.
- **Combustion fan revolution checking device:** Using the revolution sensor to monitor whether the revolution of fan is normal. When the revolution of fan deviates from the required speed, signal will be sent to the main controller to adjust the revolution.

Reminder of Adjusting Hot Water Temperature

- To suit bathing purpose of different seasons, you may adjust hot water temperature through remote control.
- In winter, there may be occasional extremely cold weather where supply water temperature is exceptionally low or required water flow is too high, hot water temperature of appliance may be relatively less. You may appropriately reduce the hot water flow by adjusting water faucet or shower tap to attain the suitable water temperature.
- In summer, there may be occasional extremely hot weather where supply water temperature is exceptionally high or required water flow is too low, hot water temperature of appliance may be relatively higher. You may deactivate the Eco mode and adjust water faucet or shower tap to mix with

Maintenance

- (1) Never use solvents to clean the body of appliance. Please wipe the surface with a soft damp cloth, then dry with a soft cloth.
- (2) Avoid spraying water onto the body of appliance and remote control.
- (3) If the water flow at shower head is reduced, the holes of shower head may be blocked. It should be checked and cleaned.
- (4) It is necessary for the appliance to be inspected and maintained regularly so that it can be used safely and efficiently.

Troubleshooting

Safety devices will keep monitoring the operation status of appliance. If a fault occurs, a fault code will be displayed on the temperature display. Please quote the code displayed when contacting customer service.

Fault	Reasons of Failure	Remedy
02	60-minute automatic stop	Turn off hot water tap, and wait for 10 seconds. Turn on hot water tap again.
10	Abnormal of air intake or flue exhaust	Please contact customer service.
11	Gas meter valve and/or gas supply valve of appliance is turned off	Fully turn on the gas meter valve and/or gas supply valve of appliance .
	Air is trapped inside gas pipe	Turn off hot water tap, and wait for 10 seconds. Turn on hot water tap again.
	Ignition failure	After turning off the remote control, check the gas meter valve and/or gas supply valve of appliance is fully turned on. Confirm the gas supply is normal without suspension. Turn on remote control again after confirmation. Turn on and then turn off the hot water tap for several times. Wait for 10 seconds each time. If the fault still persists, please contact customer service.
12	Flame failure during usage	Please contact customer service.
14	Remaining flame protection device activated	Please contact customer service.
16	Overheat protection device activated	Please contact customer service.
31	Fault or failure of sensing device for circulation water temperature	Please contact customer service.
32	Fault or failure of sensing device for outlet water temperature	Please contact customer service.
33	Fault or failure of sensing device for heat exchanger	Please contact customer service.
34	Fault or failure of sensing device for air intake temperature	Please contact customer service.
52	Fault or failure of gas control valve circuit	Please contact customer service.
61	Combustion fan fault	Please contact customer service.
63	Pre-heat circulation system fault (for TRJW162TFQL / TRJW222TFQL only)	After turning off and then turn on the remote control, reactivate the pre-heat circulation function for several times. If the fault still persists, please contact customer service.
70	Electronic control fault or failure	Please contact customer service.
71	Electronic control fault or failure	Please contact customer service.
72	Electronic control fault or failure	Please contact customer service.

In general cases, fault may be eliminated by turning off and then turning on the hot water tap again. If the fault cannot be eliminated, try to turn off the power supply and wait for 10 seconds before turning on the appliance again. If the fault still persists, please contact Customer Service Hotline on 2880 6988.

In cold and humid weather, cloudy mist may occasionally emerge from the flue terminal. The white mist is the condensate of water vapour in flue gases. This is a normal phenomenon.

Troubleshooting

Issues of hot water supply and temperature

No hot water supplied

- Check if the gas supply is normal and without suspension.
- Check if the water is running out from water tap normally.
- Check if the cold water filter is being blocked.
- Check if the power supply is normal.
- Fully turn on the gas meter valve and/or gas supply valve of appliance.
- Fully turn on the cold water valve and/or hot water tap.
- After turning on the power supply of appliance, press the ON/OFF button on remote control.

No hot water supplied immediately

- No activation of pre-heat circulation function (applicable to all models)
There is a distance between the appliance and the hot water tap, therefore, hot water cannot be supplied immediately.
- Activated pre-heat circulation function (applicable to models TRJW162TFQL and TRJW222TFQL only)
Start up time is required from activation of function to reach the set pre-heat circulation temperature, therefore, hot water cannot be supplied immediately.
- After turning on the power supply, press the ON/OFF button on remote control.

Hot water flow is fluctuated

- When the appliance is supplying hot water to a water tap with another water tap using hot water at the same time, the hot water flow will be reduced. Depending on the conditions of water supply pressure and pipework, hot water flow may be reduced suddenly or with a discontinued water flow situation. After the conditions of water supply pressure and pipework are stabilized, hot water flow will be stable.
- Due to the differences in product features of water tap, variation of hot water flow may be special feature of particular product. For example: hot water flow will be higher at the beginning and water flow will be stabilized afterward.

Hot water temperature is too high

- Fully turn on the cold water valve and/or hot water tap.
- Check if the set hot water temperature is appropriate.
- In summer, there may be occasional extremely hot weather where supply water temperature is exceptionally high or required water flow is too low, hot water temperature of appliance may be relatively higher. You may adjust water faucet or shower tap to mix with cold water for attaining suitable water temperature.

Hot water temperature is too low

- Fully turn on the gas meter valve and/or gas supply valve of appliance.
- Check if the set hot water temperature is appropriate.
- In winter, there may be occasional extremely cold weather where supply water temperature is exceptionally low or required water flow is too high, hot water temperature of appliance may be relatively less. You may appropriately reduce the hot water flow by adjusting water faucet or shower tap to attain the suitable water temperature.

Troubleshooting

Issues of hot water supply and temperature

Hot water temperature is unstable

- Fully turn on the main water supply valve to ensure sufficient water pressure.
- Increase hot water flow of mixing-type faucet to avoid the hot water flow lower than the minimum hot water flow that burner will be turned off.

Unable to adjust hot water temperature setting

- Confirm the using remote control has the priority and check if the priority indicator lights up.
- When appliance is in operation, hot water temperature can only be set to 48°C or below. If hot water temperature is set at 50°C or above, hot water temperature can only be decreased.

Issues of remote control and appliance operation

Operation indicator does not light up

- Check if the power supply is normal.
- After turning on the power supply of appliance, press the ON/OFF button on remote control.

Hot water temperature setting change automatically

- If hot water temperature is set at 50°C or above, and the appliance is in standby mode for more than 10 minutes, priority will be released, then water temperature setting will be changed to 48°C.
- If hot water temperature is set at 50°C or above, water temperature setting will be changed to 48°C when the priority is released and obtained again (if applicable).

Fan keeps operating without use of hot water

- After the burner is closed, combustion fan will keep operating for a short period of time. This is a normal phenomenon.
- Pre-heat circulation function is activated.

Flame failure during usage

- Fully turn on the gas meter valve and/or gas supply valve of appliance.
- Check if the gas supply is normal and without suspension.
- Fully turn on the cold water valve and/or hot water tap.
- Check if the water is running out from water tap normally.

Cloudy mist emerges from flue terminal

- In cold and humid weather, white mist is the condensate of water vapour in flue gases. This is a normal phenomenon.

Hot water turns milky with a cloudy status

- Dissolved air in water is released as bubbles when heated. This is normal phenomenon.

Water is discharged momentarily from the outlet of pressure relief valve

- If the water pressure inside the appliance is over the design pressure value, the pressure relief valve located near the hot water outlet will be opened to release pressure. After reducing to the design pressure value, it will then be closed.

Specifications

Model		TRJW222TFQL	TRJW162TFQL	TRJW222TFL	TRJW162TFL	
Basic Specifications	Appliance Type	Fan Draught Room-sealed Type				
	Installation Type	Free-stand Type / Ceiling-mounted Type				
	Flue Type	Top Flued Type				
	Dimension - W x H x D (mm)	453 x 370 x 280				
	Weight (kg)	24		20.5		
	Gas Type	Hong Kong Town Gas				
	Gas Supply Pressure (kPa)	1.5				
	Gas Connection	3/4" BSP Thread				
	Water Pipework Connections (mm)	Cold Water	3/4" BSP Thread			
		Hot Water	3/4" BSP Thread			
		Pre-heat Circulation	1/2" BSP Thread		/	
		Pre-heat Circulation Water Pipework Length	Maximum 60m (Output: Ø25 / Return: Ø15)		/	
	Power Supply & Signal Connections	Power	220V / 50Hz			
		Signal Cable	DC 12V (2 Pin Cable)			
	Exhaust Connections (mm)	Flue Terminal	Circular Type / Louver Type			
		Flue Diameter	Air Inlet Connection: Ø125 / Exhaust outlet Connection: Ø80			
		Flue Length	Maximum 7m & 1 bend (1 bend equivalent to 2m)			
	Ignition Type	Automatic Spark Ignition				
	Rated Heat Input (kW)	Maximum	48.0	39.3	48.0	39.3
		Minimum	2.5		4.4	
Power Consumption (W)		104		76		
		Pre-heat Circulation Pump: 30				
Level of Water-proof	Appliance Body	IPX2				
	Remote Control	IPX5				
Operation System	Amount of Hot Water Supply with 25°C Temperature Rise (L/min)	2.7 to 22.0	2.7 to 18.0	2.7 to 22.0	2.7 to 18.0	
	Amount of Hot Water Supply Range (L/min)	2.7 to 24.0	2.7 to 20.0	2.7 to 24.0	2.7 to 20.0	
	Minimum Hot Water Flow (L/min)	2.7				
	Minimum Operation Water Pressure (kPa)	10				
	Range of Normal Operation Water Pressure (kPa)	150 to 500				
	Range of Hot Water Temperature (°C)	35, 37 to 48, 50, 55 & 60 (Pre-heat: Max. 50°C)				
Safety Devices	Flame Failure Safety Device	Flame Rod Sensor				
	Remaining Flame Protection Device	Bi-metal Switch (97°C)				
	Over Boiling Protection device	Thermistor (95°C)				
	Overheat Protection Device	Thermal Fuse (129°C)				
	Over Pressure Protection Device	Water Pressure Relief Valve (ON: 1000kPa / OFF: 700kPa)		Water Pressure Relief Valve (ON: 2100kPa / OFF: 1500kPa)		
	Water Flow Sensing Device	Water Flow Sensor				
	Combustion Fan Revolution Checking Device	Revolution Sensor				
	Over Electrical Current Protection Device	Fuse (5A)				
Function	Eco Mode	Yes				
	Smart Function	Optional to purchase CCU (WiFi)				
Accessories	Remote Control (※ Optional to purchase)	BC-602Q-1H (※ BC-602Q-1H / MC-602-1H)		BC-602-1H (※ BC-602-1H / MC-602-1H)		
	Supply Water Pressure Reducing Valve Outlet Pressure	500kPa (suitable for supply pressure above 500kPa)		/		

The appliances comply with Electrical Products (Safety) Regulation in Hong Kong.

