

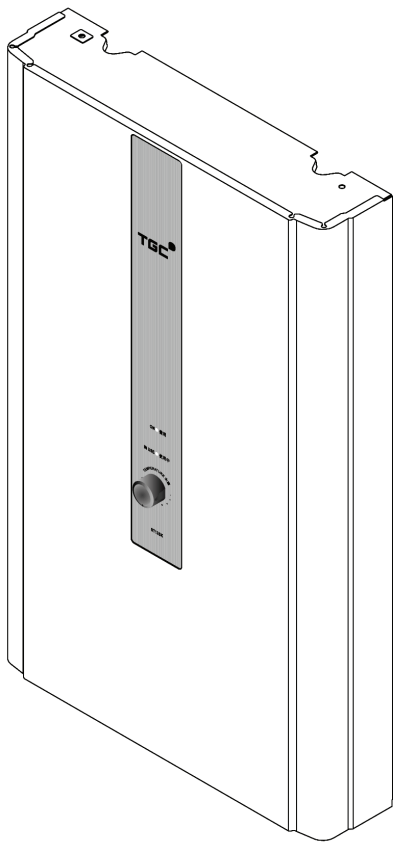

超薄型即熱式氣體熱水爐  
Super-slim Instantaneous Gas Water Heater

型號 Model : ST13SK / ST16SK / ST13SD /  
ST16SD / ST20SD

使用說明書  
Operating Instructions



ST13SK / ST16SK

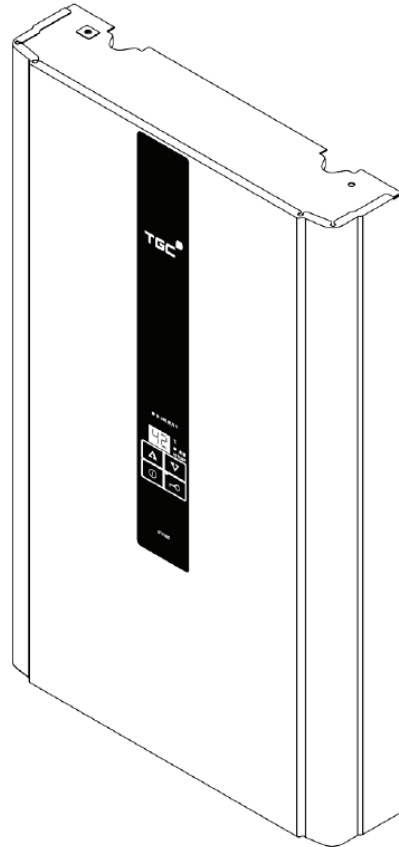

ST13SD / ST16SD / ST20SD

香港煤氣適用  
For Hong Kong Town Gas



## 目錄



重要安全指示 .....	第 1 頁
產品介紹 .....	第 5 頁
操作指示 .....	第 10 頁
保養 .....	第 15 頁
故障處理 .....	第 15 頁
規格 .....	第 18 頁

### 注意!

根據香港氣體安全條例，任何氣體裝置工程，包括爐具和接駁喉管的安裝，必須由註冊氣體裝置技工執行，而該技工已於相關的氣體工程類別註冊及受聘於註冊氣體工程承辦商。

## 重要安全指示

為安全使用本爐具，請遵照下列各項指示。下列指示對安全有莫大關係，警示及其意思如下：

 危險	若忽視此警示，並作出錯誤行動，可能引致死亡或嚴重受傷和發生火警的危險。
 警告	若忽視此警示，並錯誤使用爐具，可能引致死亡或嚴重受傷，亦可導致火警發生。
 注意	若忽視此警示，並錯誤使用爐具，可能會引致受傷和財物損毀。

上述描述所導致的受傷及財物損毀情況，請參考下列詳細描述。

- 受傷：出現損傷、燙傷及觸電等情況，並須送院治理或長期留院治療。
- 財物損毀：對房屋及傢俱等物件造成廣泛損毀。

本說明書中包含不同警示，請參考下列有關警示意思的描述。



危險、警告、  
注意



禁止



切勿觸摸



必須執行



切勿拆開



必須接到地線

### 危險

若發現本爐具出現以下問題



- 當使用爐具時，若發現異常的火焰、氣味或特別的聲音，請立即關閉熱水水龍頭及煤氣錶掣，並通知煤氣公司安排檢修。
- 在發生地震或火災時，請立即停止操作爐具。



1. 關閉熱水水  
龍頭

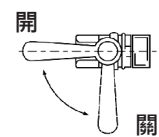

2. 關閉煤氣錶掣



切勿將煙道的出口置於室內

- 煙道的出口必須面向室外地方。

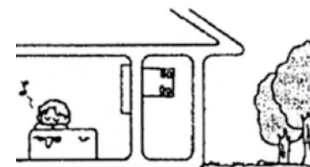

## 重要安全指示

### ⚠ 危險

#### ! 若你發覺有煤氣洩漏

1. 請停止使用本爐具，並關閉煤氣錶掣。

2. 開啟所有窗戶讓煤氣排出屋外。

3. 使用位於室外的電話與煤氣公司緊急事故熱線 2880 6999 聯絡。

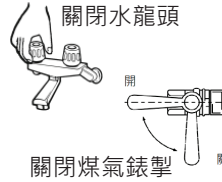

#### 若發生燃氣洩漏



- 切勿點燃明火、插拔電源插頭。
- 禁止開啟或關閉電器產品。
- 切勿在附近使用電話、手機。



切勿在漏氣處理完畢前進行上述活動或再次打開煤氣錶掣。

### ⚠ 警告

#### 請小心看管兒童



- 注入熱水到浴缸時，切勿讓兒童在浴室玩耍，以免兒童不小心掉進浴缸或導致預計不到的意外發生。
- 切勿讓兒童於沒有成人監督下洗澡。

#### 嚴禁自行拆卸、維修或改裝爐具



- 爐具的安裝、維修及其他附帶工程，必須由受僱於註冊氣體工程承辦商及領有適當類別的氣體裝置技工進行，以免造成危險或損毀爐具。

#### 切勿遮蓋煙道出口



- 請勿因增建或改建等原因令煙道出口位於室內，以避免引致一氧化碳中毒或火警危險。



## 重要安全指示



注意

### 有關安裝



- 嚴禁安裝爐具於室外地方。
- 請儘量縮短熱水喉管的長度，以及避免水管有可能導致閉塞及滯水的地方。
- 儘量縮短熱水出口與水龍頭的距離。
- 安裝煙道時，確保排出的煙氣不會直接排向外牆、窗戶、玻璃、鋼門或鋁窗框等物件，這可能會引致這些物件出現變形及變色。

### 遵照下列指示，避免火警



- 切勿於爐具或煙道周圍擺放易燃物品，如紙張、木材或衣服。
- 切勿於爐具或煙道周圍擺放或使用揮發性物品，如汽油或揮發油。
- 切勿於爐具或煙道周圍擺放或使用噴霧罐，如噴髮劑或噴霧清潔劑。

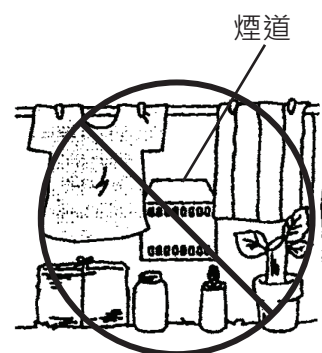

### 有關用途



- 本爐具只供家居用途。為免縮短爐具的壽命，請勿用於商業用途。
- 請勿將流經本爐具的水用作飲用或煮食用途。
- 本爐具只作供應熱水給浴室或廚房使用，切勿用作其他用途，以免發生意外或損壞爐具。

### 遵照下列指示以防燙傷



- 當使用熱水後，立即重開熱水水龍頭或迅速減慢熱水流出時，較高溫的熱水有機會突然噴出。為避免燙傷危險，切勿將熱水直接噴灑在頭和身體上。
- 當使用花灑時，較高溫的熱水可能會先流出。為避免燙傷，請先用手確認水溫。切勿直接將熱水噴灑在頭和身體上。



先用手確認水溫



- 切勿觸摸煙道，避免燙傷。

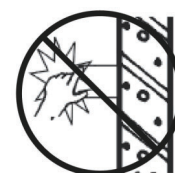

切勿觸摸煙道

## 重要安全指示



### 有關爐具控制器

- 請勿讓小孩隨意按動爐具的面板控制器及遙控器。避免造成意外或損毀爐具。

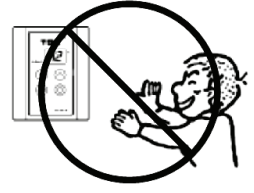

### 有關使用

- 若爐具已停用超過一星期，於使用前，應將滯留於水管內的水先排走。
- 進行排水時，請儘量避免產生水霧。使用延伸水管連接出水口及排水位。
- 排水方法：關閉爐具，將距離爐具最遠的熱水水龍頭完全開啟1分鐘。
- 為節省能源，不使用熱水時，應將爐具完全關閉。



### 有關清潔及保養

- 若爐具或喉管接觸到含氯除菌劑、酸性浴室清潔劑、除臭劑或食鹽，請用大量的清水把它們沖掉，避免造成意外或損毀爐具。
- 切勿使用溶劑或油性清潔劑清潔爐具，否則或會令爐具變色或變形。
- 請使用原廠零件及配件，避免造成意外或損毀爐具。

ST13SK / ST16SK

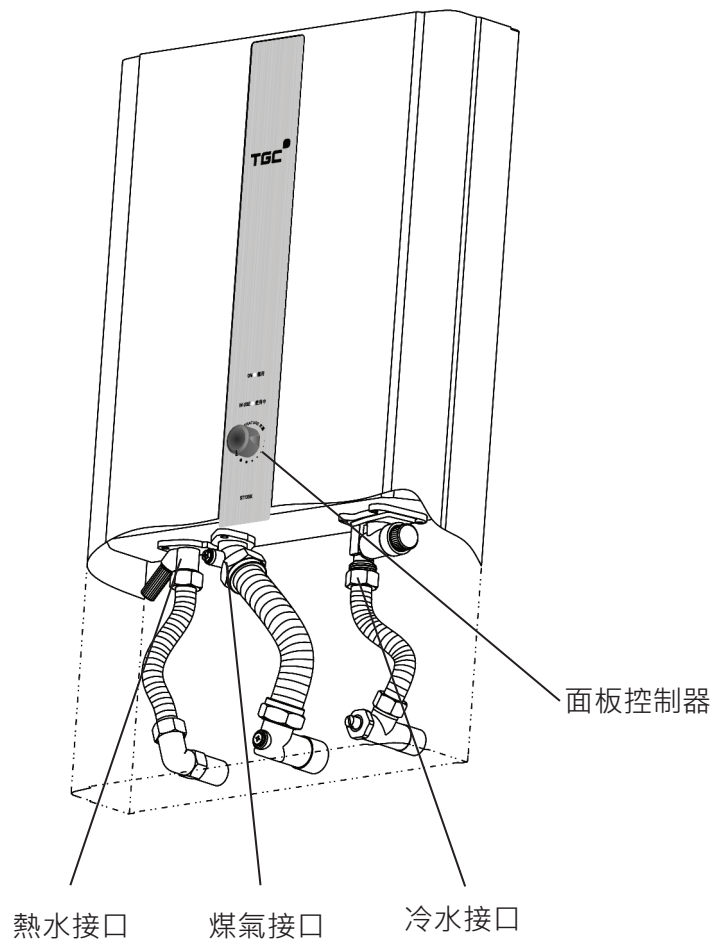

面板控制器

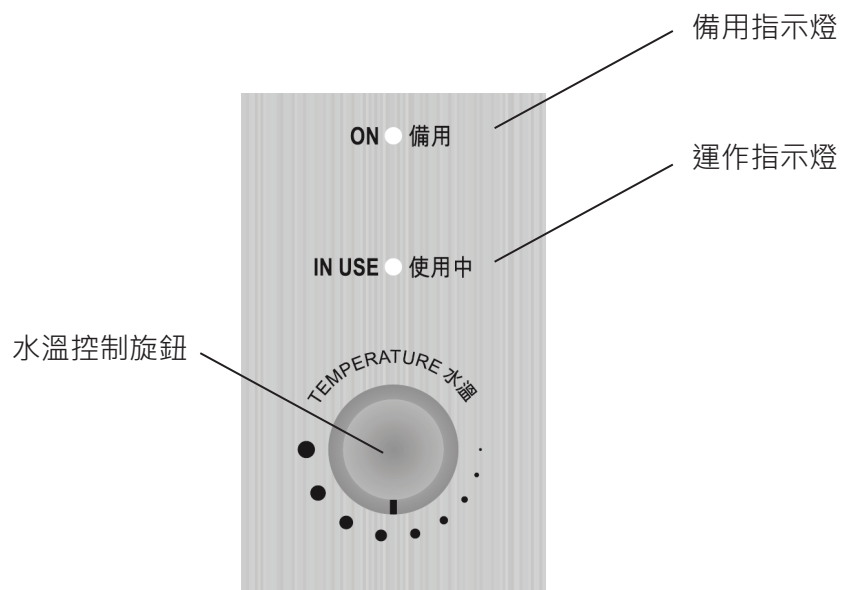



ST13SD / ST16SD / ST20SD

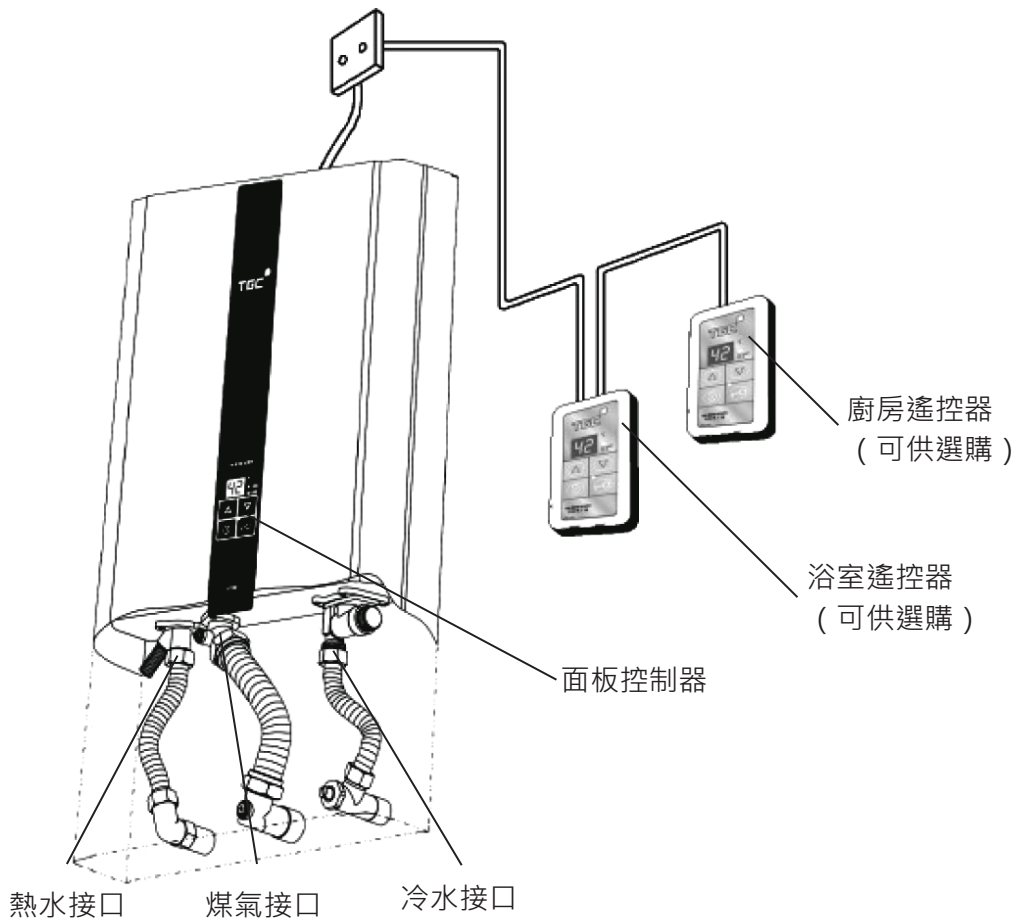

- 爐具最多可接駁 1 個浴室遙控器 ( RC-929M ) 及 1 個廚房遙控器 ( RC-929B ) 。
- 額外浴室遙控器 ( RC-929M ) 及廚房遙控器 ( RC-929B ) 亦可供選購。

面板控制器

浴室遙控器

廚房遙控器

RC-929M

RC-929B

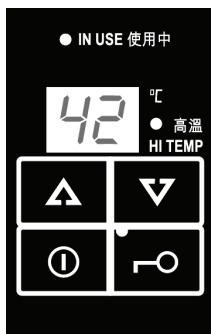

( 隨爐附送 )



( 可供選購 )



( 可供選購 )

### 面板控制器

#### 溫度顯示

- 顯示熱水溫度設定。
- 於爐具出現異常時顯示故障信號。

#### 運作指示燈

- 運作時，黃色指示燈會亮著。
- 備用狀況時，綠色指示燈會亮著。

#### 高溫指示燈

- 當熱水溫度設定為 50°C 或以上，紅色指示燈會亮起。

#### 水溫設定按鈕

- 用作調節熱水溫度。

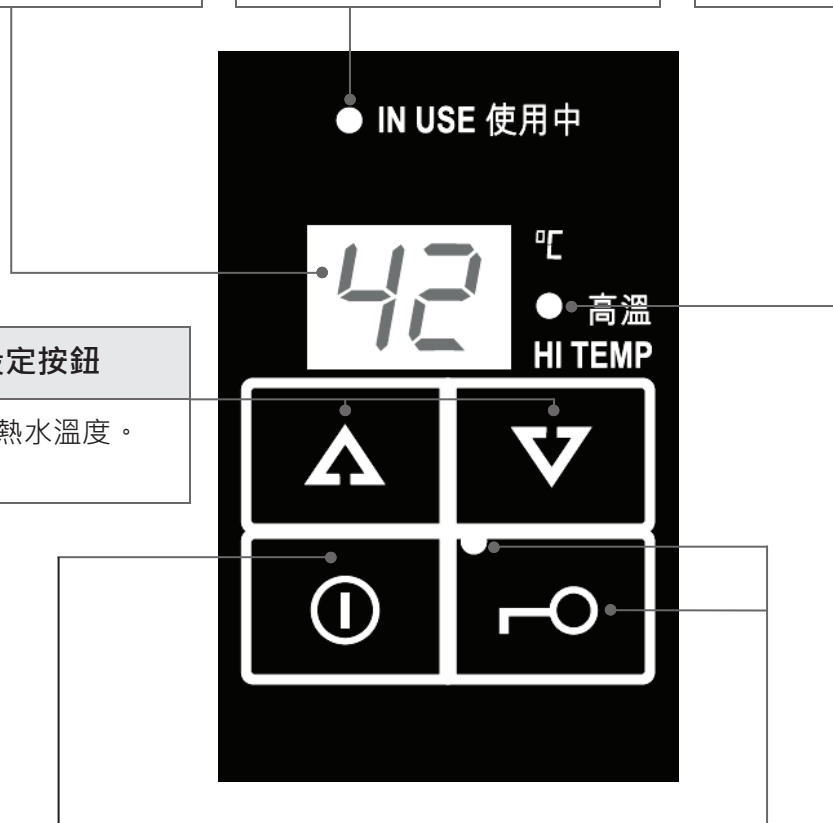

#### 開/關按鈕

- 用作啟動或關閉爐具。
- 按下按鈕啟動爐具，溫度顯示及優先指示燈會亮著。
- 擁有優先選控權的面板控制器或遙控器可按此按鈕關閉爐具。

#### 優先按鈕及指示燈

- 用作轉變面板控制器或遙控器的優先選控權。
- 按下按鈕取得優先選控權。擁有優先選控權的面板控制器或遙控器，指示燈會亮著。
- 熱水溫度可於優先指示燈亮著的面板控制器或遙控器調節。
- 如指示燈閃爍時，優先選控權不可更改。而指示燈熄滅時，重按取回優先選控權。

浴室遙控器 ( RC-929M )

溫度顯示

- 顯示熱水溫度設定。
- 於爐具出現異常時顯示故障信號。

運作指示燈

- 運作時，黃色指示燈會亮著。
- 備用狀況時，綠色指示燈會亮著。

高溫指示燈

- 當熱水溫度設定為 50°C 或以上，紅色指示燈會亮起。

水溫設定按鈕

- 用作調節熱水溫度。

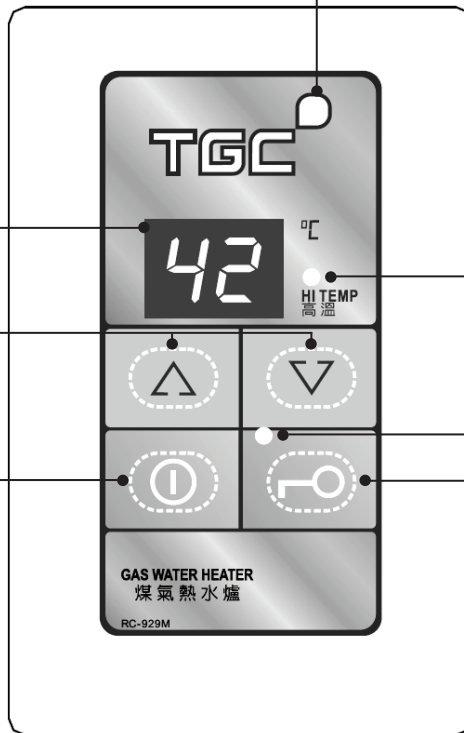

開/關按鈕

- 用作啟動或關閉爐具。
- 按下按鈕啟動爐具，溫度顯示及優先指示燈會亮著。
- 擁有優先選控權的面板控制器或遙控器可按此按鈕關閉爐具。

優先按鈕及指示燈

- 用作轉變面板控制器或遙控器的優先選控權。
- 按下按鈕取得優先選控權。擁有優先選控權的面板控制器或遙控器，指示燈會亮著。
- 熱水溫度可於優先指示燈亮著的面板控制器或遙控器調節。
- 如指示燈閃爍時，優先選控權不可更改。而指示燈熄滅時，重按取回優先選控權。

廚房遙控器 ( RC-929B )

溫度顯示

- 顯示熱水溫度設定。
- 於爐具出現異常時顯示故障信號。

運作指示燈

- 運作時，黃色指示燈會亮著。
- 備用狀況時，綠色指示燈會亮著。

高溫指示燈

- 當熱水溫度設定為 50°C 或以上，紅色指示燈會亮起。

水溫設定按鈕

- 用作調節熱水溫度。

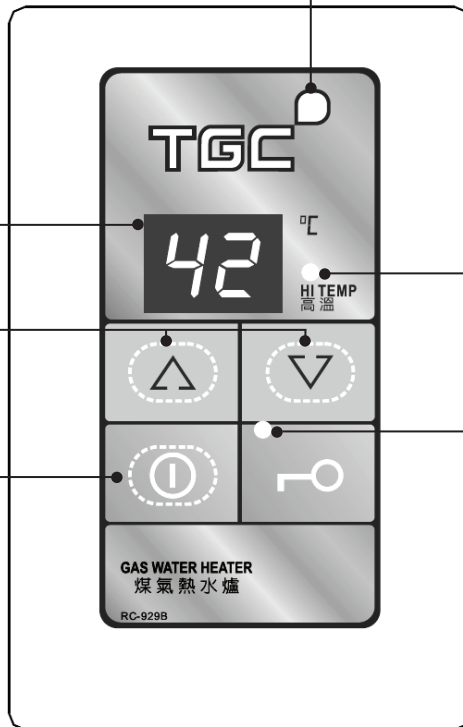

開/關按鈕

- 用作啟動或關閉爐具。
- 按下按鈕啟動爐具，溫度顯示及優先指示燈會亮著。
- 擁有優先選控權的面板控制器或遙控器可按此按鈕關閉爐具。
- 優先指示燈熄滅時，按下按鈕取得優先選控權。

優先指示燈

- 擁有優先選控權的遙控器，指示燈會亮著。
- 熱水溫度可於優先指示燈亮著的面板控制器或遙控器調節。
- 如指示燈閃爍時，優先選控權不可更改。

## 操作指示

### 注意

- 首次或於早上使用爐具時，供氣管道內有機會因殘留空氣而無法即時點燃燃燒器。請關閉熱水水龍頭，待 10 秒後再開啟熱水水龍頭，重複自動點燃程序。

- 為避免燙傷：

- 淋浴前請先用手確認水溫，切勿直接將熱水噴灑在頭和身體上。
- 使用高溫熱水後，水管中仍存有高溫熱水。再次使用較低溫的熱水時，應先用手確認水溫，待溫度適合後才使用。



先用手確認水溫



- ST13SD、ST16SD 及 ST20SD 型號，於熱水水溫設定為 50°C或以上時，高溫指示燈會亮起。請小心使用高溫熱水。
- 在供水壓力較高的情況下，使用爐具時有機會出現較大的水流聲，此屬正常現象。
- 長時間不使用爐具時，請關閉冷水水掣及爐具供氣閥。

### 初次使用爐具

請按以下指示檢查爐具運作。

- 將水溫控制旋鈕轉至最小旋鈕標示位置，或將熱水水溫調節至 35°C 的設定。完全開啟熱水水龍頭，並確認熱水流出後關閉。

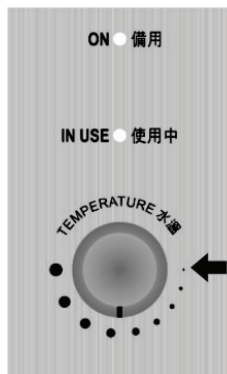

ST13SK / ST16SK

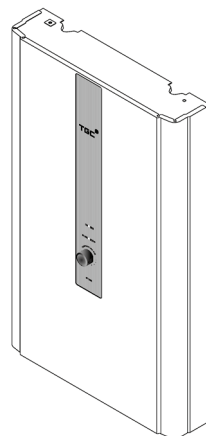

ST13SD /  
ST16SD / ST20SD

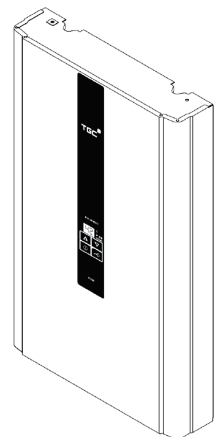

## 使用爐具

### ( 1 ) 開啟爐具

- 啟動爐具電源後，面板控制器的備用指示燈會亮起。此時爐具處於備用狀態。

### ( 2 ) 設定熱水水溫

- 利用水溫控制旋鈕可調節熱水水溫。
- 順時針轉動調高熱水水溫，逆時針轉動調低熱水水溫。
- 「·」為最低水溫，而「●」則為最高水溫。

### ( 3 ) 使用熱水

- 開啟熱水水龍頭後，燃燒器會自動點燃，熱水隨即流出。黃色使用中指示燈會亮起。
- 熱水流量低於最低熱水流量時，燃燒器便會關閉。因此熱水水龍頭不宜開啓過小，否則使用時有機會出現無法燃點或中途熄火現象。

### ( 4 ) 停止操作

- 關閉熱水水龍頭後，爐具立即停止運作，熱水停止流出。使用中指示燈會熄掉。
- 需再次使用熱水時，重複步驟 ( 1 ) 至 ( 3 )。
- 關閉爐具電源後，所有指示燈會熄滅。

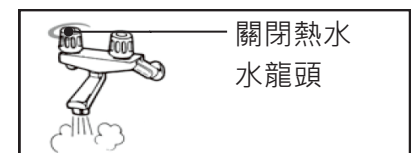
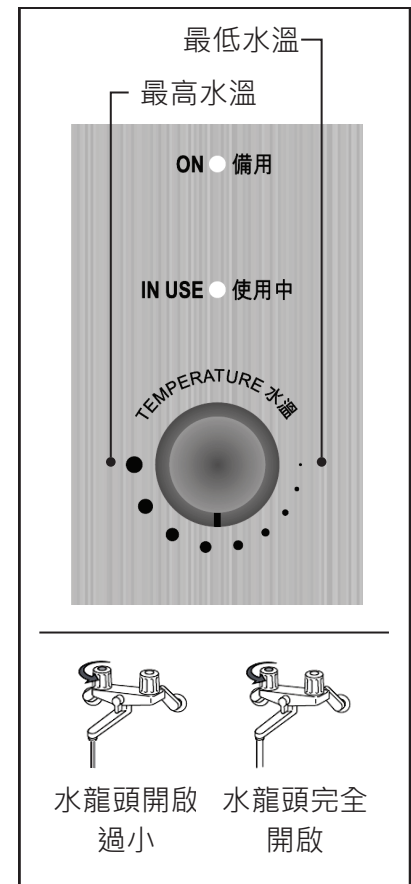
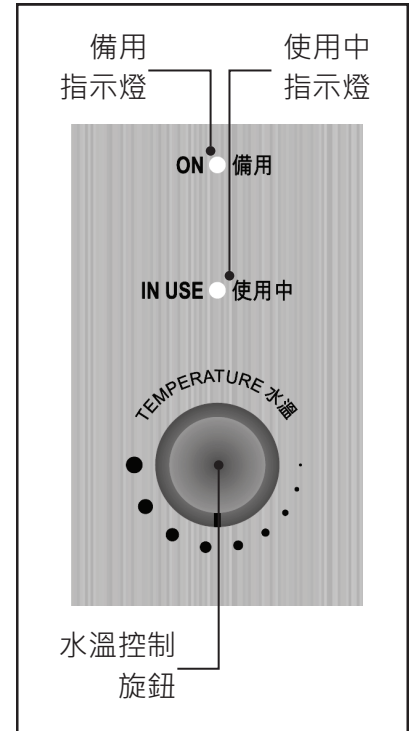

## 使用爐具

### ( 1 ) 啟動爐具

- 啟動爐具電源後，按面板控制器或遙控器上的開/關按鈕。
- 溫度顯示及優先指示燈亮起，此時爐具處於備用狀態。
- 用作啟動爐具的面板控制器或遙控器即擁有優先選擇權，優先指示燈會亮起。當優先指示燈閃爍時，優先選控權不能轉換。
- 安裝後首次使用時，預設溫度為 42°C。



### ( 2 ) 設定熱水水溫

- 利用擁有優先選擇權的遙控器可調節熱水水溫。
  - 按「▲」及「▼」按鈕調節熱水水溫。以「▲」按鈕調高熱水水溫；以「▼」按鈕調低熱水水溫。熱水水溫可調節範圍為：
  - 35°C為最低水溫，而 60°C則為最高水溫。
- 35 37 38 39 40 41 42 43 44 45 46 47 48 50 55 60
- 所設定的熱水溫度會同時顯示於所有遙控器的溫度顯示上。
  - 熱水溫度設定為 50°C或以上時，高溫指示燈會亮起。



### ( 3 ) 使用熱水

- 開啟熱水水龍頭後，燃燒器會自動點燃，熱水隨即流出。黃色運作指示燈會亮起。
- 熱水流量低於最低熱水流量時，燃燒器便會關閉。因此熱水水龍頭不宜開啓過小，否則使用時有機會出現無法燃點或中途熄火現象。
- 爐具運作時，熱水溫度只可設定為 48°C 或以下。如熱水溫度已設定為 50°C 或以上，熱水溫度只可調低。

### ( 4 ) 停止使用熱水

- 關閉熱水水龍頭後，爐具立即停止運作，熱水停止流出。運作指示燈會熄掉。
- 需再次使用熱水時，重複步驟 ( 1 ) 至 ( 3 )。
- 擁有優先選控權的面板控制器或遙控器才能關閉爐具。按遙控器上的開/關按鈕，所有顯示及指示燈會熄滅。

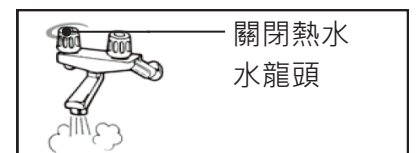
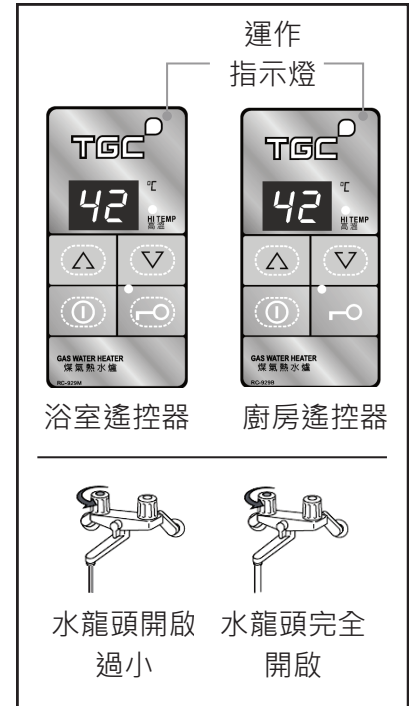

# 操作指示 ( ST13SD / ST16SD / ST20SD )

## 轉換優先選控權 ( 安裝多個遙控器 )

- 安裝一個或以上 ( 最多兩個 ) 的遙控器，只有擁有優先選控權的面板控制器或遙控器才可設定熱水溫度，以防止意外發生，如燙傷等。
- 當面板控制器或浴室遙控器擁有優先選控權，其優先指示燈會亮起，而其他遙控器上的優先指示燈會閃爍。
- 當廚房遙控器擁有優先選控權，其優先指示燈會亮起，而其他遙控器上的優先指示燈會熄滅。
- 利用面板控制器或浴室遙控器可轉換優先選控權至廚房遙控器。
- 優先選控權不能於優先指示燈閃爍時或爐具正在運作時轉換。



面板控制器/ 浴室遙控器\* 廚房遙控器\*  
浴室遙控器\*

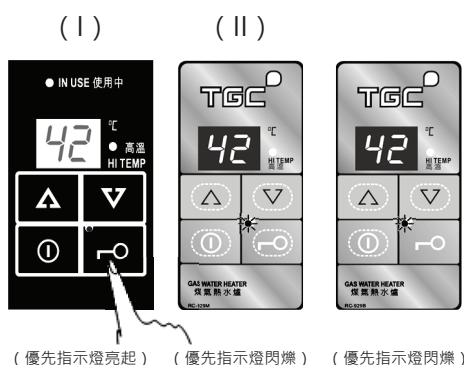

按動面板控制器或浴室遙控器 ( I ) 的優先按鈕獲取優先選控權。

面板控制器/ 浴室遙控器\* 廚房遙控器\*  
浴室遙控器\*

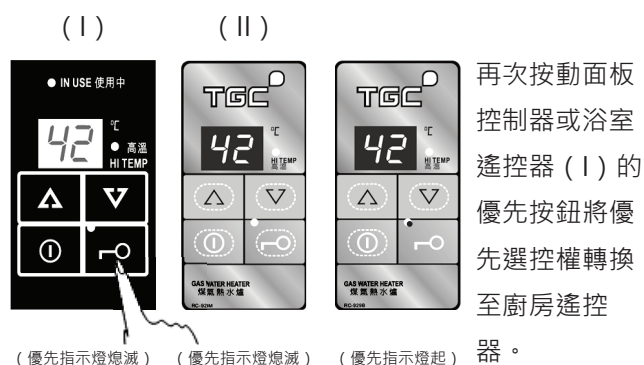

再次按動面板控制器或浴室遙控器 ( I ) 的優先按鈕將優先選控權轉換至廚房遙控器。

面板控制器/ 浴室遙控器\* 廚房遙控器\*  
浴室遙控器\*

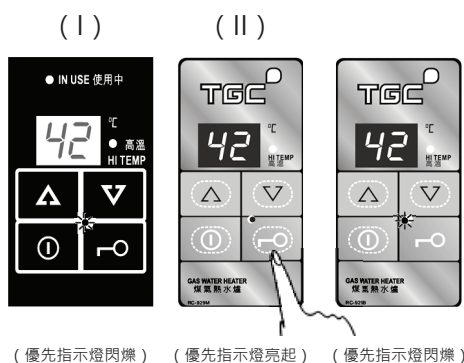

按動浴室遙控器 ( II ) 的優先按鈕獲取優先選控權。

面板控制器/ 浴室遙控器\* 廚房遙控器\*  
浴室遙控器\*

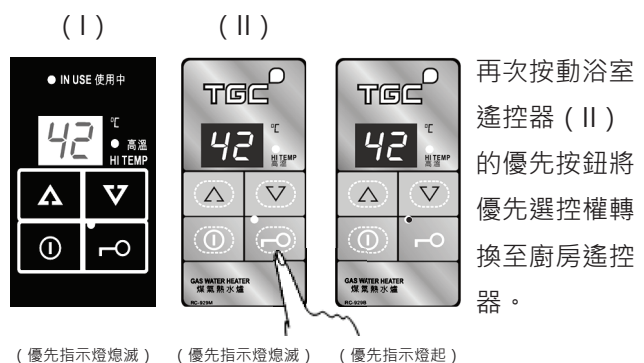

再次按動浴室遙控器 ( II ) 的優先按鈕將優先選控權轉換至廚房遙控器。

\* 浴室遙控器 ( I ) 及 ( II ) 為 RC-929M。廚房遙控器為 RC-929B。

- 每個面板控制器或遙控器均可記存其之前擁有優先選控權所設定的溫度 ( 最高 48°C )，取得優先選控權時，先前溫度設定將顯示於溫度顯示。
- 當爐具處於備用狀態超過 10 分鐘，優先選控權會自動解除，所有優先指示燈會關掉。再使用爐具時，爐具會按照之前擁有優先選控權的面板控制器或遙控器所設定的溫度提供熱水。
- 設定溫度為 50°C或以上時，於優先選控權解除後，溫度設定將變更為 48°C。



## 操作指示

### 安全裝置

- **熄火安全裝置**：裝置利用火焰感應棒監察燃燒狀態是否正常。當火焰失效時，火焰失效信號會傳送到主控器以停止供氣。
- **殘火保護裝置**：熱水水龍頭關閉後，若火焰仍然存在而熱交換器內的熱水溫度高達設計溫度時，裝置會停止供氣。
- **防止過度沸騰保護裝置**：當熱水溫度高於設計溫度時，裝置會啟動，並停止爐具運作。
- **防止過熱保護裝置**：當熱交換器燒毀或溫度高於設計溫度時，裝置會啟動，並停止爐具運作。
- **防止過高水壓保護裝置**：當爐具內的水壓高於設計水壓，位於熱水出口的水洩壓閥會打開洩壓，並於水壓降回設計水壓時關閉。
- **水流量感應裝置**：當冷水水流受到阻隔或被中止，裝置會啟動，並停止爐具運作。
- **助燃風扇轉速檢查裝置**：裝置利用轉速感應器監察風扇的轉速是否正常。當風扇轉速與要求轉速有所偏差時，信號會傳送到主控器以調整轉速。

型號	ST13SK / ST16SK	ST13SD / ST16SD / ST20SD
殘火保護裝置設計溫度	100°C	
防止過度沸騰保護裝置設計溫度	92°C	
防止過熱保護裝置設計溫度	140°C	
防止過高水壓保護裝置	啟動水壓	2100kPa
	關閉水壓	1700kPa

### 調節熱水溫度提示

- ST13SK / ST13SD 可提供每分鐘 12.8 公升流量（升溫 25°C）的熱水；ST16SK / ST16SD 可提供每分鐘 16.8 公升流量（升溫 25°C）的熱水；ST20SD 可提供每分鐘 19.8 公升流量（升溫 25°C）的熱水。為配合在不同季節的沐浴使用，可透過面板控制器/遙控器調節所需的熱水溫度。
- 在冬季偶有極寒冷的天氣，自來水的溫度可能過低或熱水流量過大，爐具的出水溫度可能會比較低，您可以調節水龍頭或花灑掣來減少熱水水流量，以便獲得適合的水溫。
- 在夏季偶有極炎熱的天氣，自來水的溫度可能過高或熱水流量過小，爐具的出水溫度可能會比較高，您可以調節水龍頭或花灑掣輔以混合冷水，以便獲得適合的水溫。

## 保養

- (1) 爐具機身及遙控器不可用溶劑清潔，應使用濕軟布揩抹，再用乾軟布抹乾。
- (2) 遙控器備有防水設計，但亦儘量避免向遙控器噴水。
- (3) 如花灑出水量變少，花灑頭的水孔可能已堵塞。應檢查並加以清理。
- (4) 必須定期檢查及保養爐具，以確保使用上的安全及效率。

## 故障處理

安全裝置會持續監察爐具運作的狀況。當故障發生時，ST13SK/ST16SK 會以指示燈號通知故障情況，而 ST13SD/ST16SD/ST20SD 的故障信號則會立即顯示在溫度顯示上。當致電維修服務時，請描述故障情況或直接提供故障時所顯示的號碼。

型號	故障訊號	故障內容	處理方法
ST13SK / ST16SK	備用指示燈未有亮起。	未有開啟爐具電源。	開啟爐具電源。
	備用指示燈正在閃動。	1) 煤氣掣被關閉	開啟煤氣掣。
2) 爐具長時間沒有使用		關閉熱水水龍頭，然後重新開啟水龍頭。重複所述步驟數次，每次開關相隔約 10 秒。	
ST13SD / ST16SD / ST20SD	E1	1) 煤氣掣被關閉	開啟煤氣掣。
		2) 爐具長時間沒有使用	關閉熱水水龍頭，然後重新開啟水龍頭。重複所述步驟數次，每次開關相隔約 10 秒。
		3) 點火失誤	關掉控制器，然後檢查煤氣閥是否開啟，而煤氣供應是否中斷。若煤氣供應正常，重新開啟控制器，當開和關熱水龍頭數次後，每次開關相隔約 10 秒。如錯誤訊息仍然存在，請致電維修服務。
	E2	火焰檢測失誤	請致電維修服務。
	E3	熄火安全裝置啟動	請致電維修服務。
	E4	殘火安全裝置啟動	請致電維修服務。
	E5	過熱保護裝置啟動	請致電維修服務。
	E6	使用中停電再恢復供電	關閉熱水水龍頭，然後重新開啟水龍頭。重複所述步驟數次，每次開關相隔約 10 秒。
		沸騰保護裝置啟動	請致電維修服務。
	E7	助燃風扇出現問題	請致電維修服務。
	E8	溫度控制器出現問題	請致電維修服務。
E9	60分鐘停止運作裝置啟動	關閉熱水水龍頭，然後重新開啟水龍頭。	

在一般情況下，關閉熱水水龍頭然後重新開啟，故障情況或信號有可能消除。若故障情況或信號仍然存在，可先嘗試關閉供電電源，等待 10 秒後重新啟動爐具。如故障信號繼續存在，請致電煤氣公司客戶服務熱線 2880 6988。

在寒冷及潮濕的天氣，煙道出口偶會冒出煙霧，這是煙氣中的水氣遇冷而形成白色煙霧，此屬正常現象。

### 關於熱水供應及溫度

#### 沒有熱水供應

- 檢查供氣是否正常及有否出現中斷。
- 檢查水龍頭是否出水正常。
- 檢查冷水過濾網是否被堵塞。
- 檢查供電是否正常。
- 完全開啟煤氣錶閥及 / 或爐具供氣閥。
- 完全開啟冷水水掣及 / 或熱水水龍頭。
- 啟動爐具電源後，並按面板控制器或遙控器上的開/關按鈕。

#### 熱水沒有即時流出

- 啟動電源後，按面板控制器或遙控器上的開/關按鈕。
- 從爐具到熱水水龍頭間存在一段距離，因此熱水未能即時流出。

#### 熱水流量出現變化

- 如爐具正於一個水龍頭供應熱水，並於另一個水龍頭需同時供應熱水時，熱水水流量會減少。而因應供水水壓及水管狀況，有機會出現熱水水流量驟降或水流斷續的情況。待供水水壓及水管狀況穩定後，熱水水流會穩定下來。
- 因不同水龍頭產品於特性上有所差異，熱水水流量的改變有機會屬個別產品的特性。例如：熱水水流於剛流出時會較多，後續水流將趨於穩定。

#### 熱水溫度過高

- 完全開啟冷水水掣及 / 或熱水水龍頭。
- 檢查所設定的熱水溫度是否適當。
- 在夏季偶有極炎熱的天氣，自來水的溫度可能過高或熱水流量過小，爐具的出水溫度可能會比較高，您可以調節水龍頭或花灑掣輔以混合冷水，以便獲得適合的水溫。

#### 熱水溫度過低

- 完全開啟煤氣錶閥及 / 或爐具供氣閥。
- 檢查所設定的熱水溫度是否適當。
- 在冬季偶有極寒冷的天氣，自來水的溫度可能過低或熱水流量過大，爐具的出水溫度可能會比較低，您可以調節水龍頭或花灑掣來減少熱水水流量，以便獲得適合的水溫。

### 關於熱水供應及溫度

- 熱水溫度不穩定
- 完全開啟供水主閥，確保供水壓力足夠。
  - 增加混合水龍頭的熱水量，避免因熱水流量低於最低熱水流量，而導致燃燒器關閉。
- 不能調節熱水溫度設定
- 確認使用的面板控制器或遙控器擁有優先選擇權，檢查優先指示燈是否亮起。
  - 爐具運作時，熱水溫度只可設定為 48°C 或以下。如熱水溫度已設定為 50°C 或以上，熱水溫度只可調低。

### 關於面板控制器、遙控器及爐具運作

- 開/關指示燈沒有亮起
- 檢查供電是否正常。
  - 啟動爐具電源後，並按面板控制器或遙控器上的開/關按鈕。
- 熱水溫度設定自行變更
- 當爐具處於備用狀態超過 10 分鐘，優先選控權會自動解除。設定溫度為 50°C 或以上時，於優先選控權解除後，溫度設定將變更為 48°C。
- 沒有使用熱水，但風扇仍然運作
- 燃燒器關閉後，助燃風扇仍維持短暫運作，此屬正常運作。
- 使用中途熄火
- 完全開啟煤氣錶閥及 / 或爐具供氣閥。
  - 檢查供氣是否正常。
  - 完全開啟冷水水掣及 / 或熱水水龍頭。
  - 檢查水龍頭是否出水正常。
- 排煙管出口冒出煙霧
- 在寒冷及潮濕的天氣，煙氣中的水氣遇冷形成白色煙霧，此屬正常現象。
- 熱水出水變為白色並出現渾濁情況
- 水中溶解的空氣受熱後，形成氣泡，此屬正常運作。
- 偶然於水洩壓閥出口短暫流出水份
- 爐具內水壓高於設計水壓，位於熱水出口的水洩壓閥會打開洩壓，並於水壓降回設計水壓時關閉。

# 規格

型號		ST13SK		ST13SD				
銷售代號		ST13SK-W	ST13SK-WH	ST13SD-W	ST13SD-G	ST13SD-WH	ST13SD-WL	
基本規格	爐具類別	機動排煙密封式						
	安裝方式	掛牆式						
	排氣方式	背排						
	尺寸 - 闊 x 高 x 深 (毫米)	360 x 587.5 x 78	360 x 670 x 78	360 x 587.5 x 78	360 x 587.5 x 78	360 x 670 x 78	360 x 670 x 78	
	重量 (千克)	16						
	燃氣種類	香港煤氣						
	供氣壓力 (千帕)	1.5						
	燃氣接駁	M28 x P1.5 螺紋						
	水管接駁	冷水	1/2" 英制螺紋					
		熱水	1/2" 英制螺紋					
	供電及信號接駁	電源	220 伏特 / 50 赫茲					
		信號線	12伏特 直流電 (雙芯線)					
	點火方式	自動電子點火						
	額定熱負荷 (千瓦)	最高	27.9					
		最低	7.6					
	耗電量 (瓦)	65						
防水能力	機身	IPX4						
	遙控器	IPX4						
系統運作	熱水供應能力25°C升溫 (公升/分鐘)	3.5 至 12.8						
	熱水供應量範圍 (公升/分鐘)	3.0 至 12.8						
	最低熱水流量 (公升/分鐘)	3.0						
	最低運作水壓 (千帕)	20						
	正常運作水壓範圍 (千帕)	70 至 300						
	熱水水溫選擇 (°C)	/		35、37 至 48、50、55 及 60				
安全裝置	熄火安全裝置	火焰感應棒						
	殘火保護裝置	雙金屬開關 (100°C)						
	防止過度沸騰保護裝置	熱敏電阻 (92°C)						
	防止過熱保護裝置	溫度保險絲 (140°C)						
	防止過高水壓保護裝置	水洩壓閥 (啟動: 2100 千帕)						
	水流量感應裝置	水流感應器						
	助燃風扇轉速檢查裝置	轉速感應器						
	電流過大保護裝置	保險絲 (3A)						
控制器及配件	面板控制器	旋鈕		溫度顯示及按鈕				
	遙控器 (有線) ※可供選購	/		最多可配2個 ※RC-929M / RC-929B				

本爐具符合香港電氣產品 (安全) 規例。

## 規格

型號	ST16SK	ST16SD		ST20SD			
銷售代號	ST16SK-W	ST16SD-W	ST16SD-G	ST20SD-W	ST20SD-G	ST20SD-WH	
基本規格	爐具類別	機動排煙密封式					
	安裝方式	掛牆式					
	排氣方式	背排					
	尺寸 - 闊 x 高 x 深 (毫米)	360 x 587.5 x 78	360 x 587.5 x 78	360 x 587.5 x 78	360 x 587.5 x 78	360 x 587.5 x 78	360 x 670 x 78
	重量 (千克)	17			22		
	燃氣種類	香港煤氣					
	供氣壓力 (千帕)	1.5					
	燃氣接駁	M28 x P1.5 螺紋					
	水管接駁	冷水	1/2" 英制螺紋				
		熱水	1/2" 英制螺紋				
	供電及信號接駁	電源	220 伏特 / 50 赫茲				
		信號線	12伏特 直流電 (雙芯線)				
	點火方式	自動電子點火					
	額定熱負荷 (千瓦)	最高	36.6			43.2	
		最低	9.8			7.6	
	耗電量 (瓦)	77			77		
防水能力	機身	IPX4					
	遙控器	IPX4					
系統運作	熱水供應能力25°C升溫 (公升/分鐘)	4.5 至 16.8			3.5 至 19.8		
	熱水供應量範圍 (公升/分鐘)	3.0 至 16.8			3.0 至 19.8		
	最低熱水流量 (公升/分鐘)	3.0					
	最低運作水壓 (千帕)	20					
	正常運作水壓範圍 (千帕)	70 至 300					
	熱水水溫選擇 (°C)	/	35、37 至 48、50、55 及 60				
安全裝置	熄火安全裝置	火焰感應棒					
	殘火保護裝置	雙金屬開關 (100°C)					
	防止過度沸騰保護裝置	熱敏電阻 (92°C)					
	防止過熱保護裝置	溫度保險絲 (140°C)					
	防止過高水壓保護裝置	水洩壓閥 (啟動: 2100 千帕)					
	水流量感應裝置	水流感應器					
	助燃風扇轉速檢查裝置	轉速感應器					
	電流過大保護裝置	保險絲 (3A)					
控制器及配件	面板控制器	旋鈕	溫度顯示及按鈕				
	遙控器 (有線) ※可供選購	/	最多可配2個 ※RC-929M / RC-929B				

本爐具符合香港電氣產品 (安全) 規例。

# Contents



Important Safety Instructions .....	P. 1
Product Descriptions .....	P. 5
Operating Instructions .....	P. 10
Maintenance .....	P. 15
Trouble Shooting .....	P. 15
Specifications .....	P. 18

## **Attention!**

According to the Gas Safety Ordinance of Hong Kong, any gas installation works including the installation of appliances and connection tubing, must be undertaken by registered gas installers who are registered for that appropriate classes and be employed by registered gas contractor.

# Important Safety Instructions

In order to use this appliance safely, please be sure to follow the below guidelines. The following guidelines have an important bearing on safety. Symbols and their meanings are as below.

 <b>Danger</b>	If you ignore this warning sign and act mistakenly, it may incur death, or serious injury and will lead to an imminent danger of fire breaking out.
 <b>Warning</b>	If you ignore this warning sign and mistakenly handle the appliance, it may incur death or serious injury and may lead to fire incident.
 <b>Caution</b>	If you ignore this warning sign and mistakenly handle the appliance, this may incur injury or property damage.

The above injuries and properties damage refer specifically to the following descriptions.

- Injury: injuries, burns and electric shocks etc. that require treatment in hospital or long-term hospitalization.
- Properties Damage: widespread damage to house and furnishings.

In this user instructions includes different symbols, please refer to the following descriptions for the meanings of corresponding symbols.

					
<b>Danger, warning, caution</b>	<b>Forbidden</b>	<b>Do not touch</b>	<b>Be sure to do</b>	<b>Disassembly is forbidden</b>	<b>Must be earthed</b>

## ⚠ **Danger**

### **If you notice following problems with this appliance**



- If you notice abnormal flames, gas smell or strange sounds when using the appliance, please turn off hot water tap and gas meter valve immediately and contact the Towngas company.
- In the event of earthquake or fire, cease operation without hesitation.



1. Turn off hot water tap

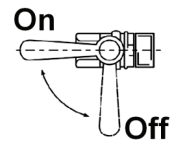

2. Turn off gas meter valve



### **Do not place the outlet of flue terminal indoor**

- The outlet of flue terminal should be faced outdoor.

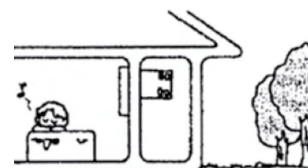



# Important Safety Instructions



## Danger



### If you notice a gas leak

1. Cease use and turn off the gas meter valve.

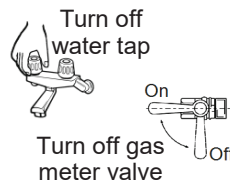

2. Open all windows to disperse the gas.



3. Call Towngas Emergency Hotline on 2880 6999 with a phone outside the premises.



### If there is a gas leak



- Do not ignite a fire, insert or remove power plug.
- Turning on or off any electrical appliance is forbidden.
- Do not use telephone or mobile phone nearby.



Do not perform any of the above actions or turn on the gas meter valve again until the gas leak is fixed.



## Warning

### Care to be taken with children



- When filling hot water into the bath-tub, do not allow children to play in the bathroom to avoid the children falling into the bath-tub or causing any dangers.
- Do not allow children to bath without the supervision of adult.

### Self disassembling, repairing and modification of appliance are strictly forbidden



- Gas installer, who performs any installation, maintenance and its related work of appliance, shall be employed by registered gas contractor and be registered under appropriate class of gas installation work to prevent hazard or damage of appliance.

### Do not cover outlet of flue terminal



- Do not place the outlet of flue terminal in an indoor environment due to additions or reconstruction in order to avoid the occurrence of carbon monoxide poisoning or fire hazard.



# Important Safety Instructions



## Caution

### Regarding installation



- Do not install the appliance at outdoor.
- Minimize pipe length and avoid dead legs and stagnant corners in hot water pipework.
- Minimize the distance between hot water outlet and water tap.
- When installing the flue terminal, make sure the flue gas does not discharge directly to the outside walls, windows, glass, mesh doors or aluminum sashes etc. This could cause material disfiguration or discolouration.

### What you must do to prevent fire



- Do not place flammable materials, such as paper, wood or clothes, around the appliance or flue terminal.
- Do not place or use volatile materials, such as gasoline or benzene, around the appliance or flue terminal.
- Do not place or use spray cans, such as hair spray or spray cleaners, around the appliance or flue terminal.

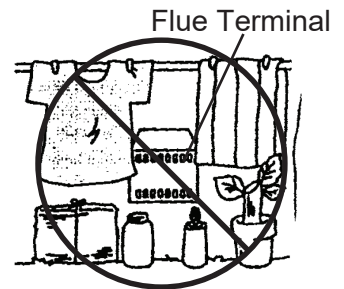

### Regarding use



- This appliance is intended for residential application only. Do not use it for commercial application lest its service life is shortened.
- Do not use water from the appliance for drinking or cooking.
- This appliance is intended for supplying hot water to bathroom and kitchen. Do not use it for other purpose in order to avoid incident or damage of appliance.

### What you must do to prevent scalding



- When turning on the tap again after using hot water or quickly reducing the hot water flow, relatively high-temperature hot water may suddenly come out. As there is a risk of being scalded, do not direct the hot water onto your head or body.
- When using the shower, relatively high-temperature hot water may come out first. In order to prevent scalding, check the hot water temperature with hand first. Do not direct the hot water onto the head or body.



Check hot water temperature with hand first



- Do not touch the flue terminal to prevent from scalding.



Do not touch flue terminal

# Important Safety Instructions



## Caution



### Regarding control unit of appliance

- Keep the front panel control and remote control out of reach of children. It is intended to prevent accidents or damage of appliance.

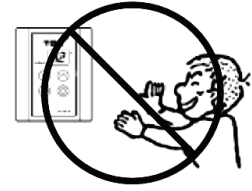

---

### Regarding operation



- If appliance is not used for more than one week, drain away stagnant water inside the water pipework before use.
- During water purging, avoid generation of water mist. Use extension pipe to connect water outlet and drain point.
- Method of water purging: Turn off the appliance, fully turn on the most distant hot water tap from the appliance for 1 minute.
- To save energy, switch off appliance completely when hot water is not used.

---

### Regarding cleaning and maintenance



- If the appliance or pipework circuits are in contact with chlorine-based fungicides, acidic bathroom cleaners, deodorants or salt, wash them off with ample water straight away to prevent causing accidents or damage of appliance.
  - Do not use solvent or oil-based cleaners to clean the appliance. This could cause discolouration or disfiguration of appliance.
  - Use only genuine parts for this appliance to prevent causing accidents or damage of
-

# Product Descriptions (ST13SK / ST16SK)

## ST13SK / ST16SK

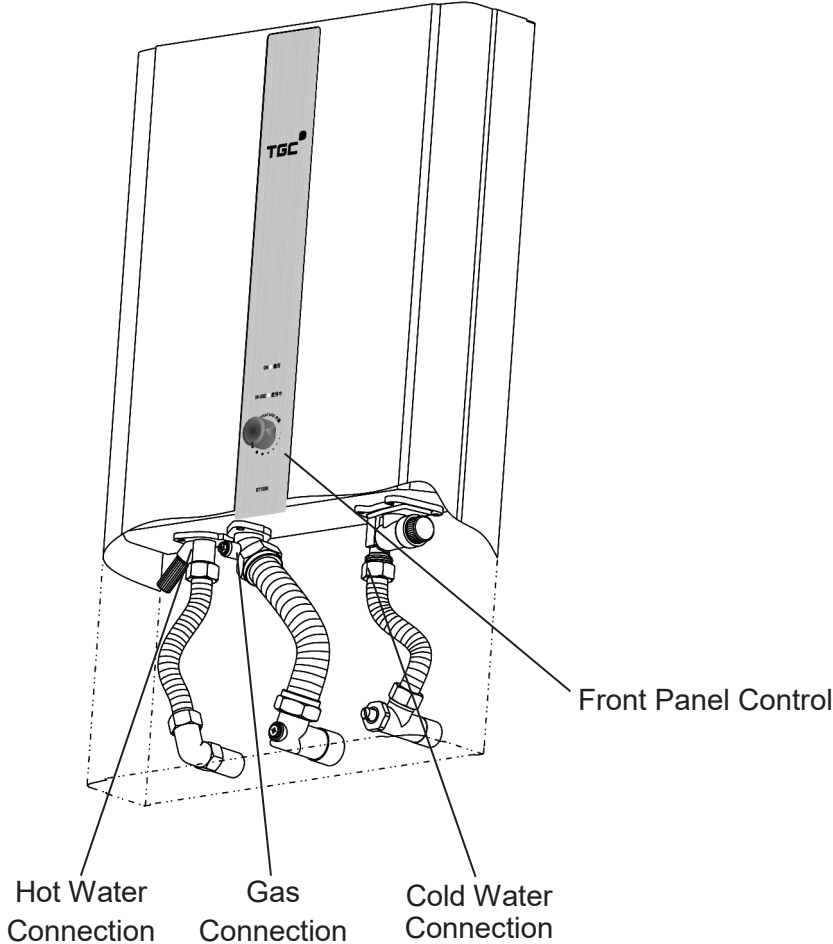

## Front Panel Control

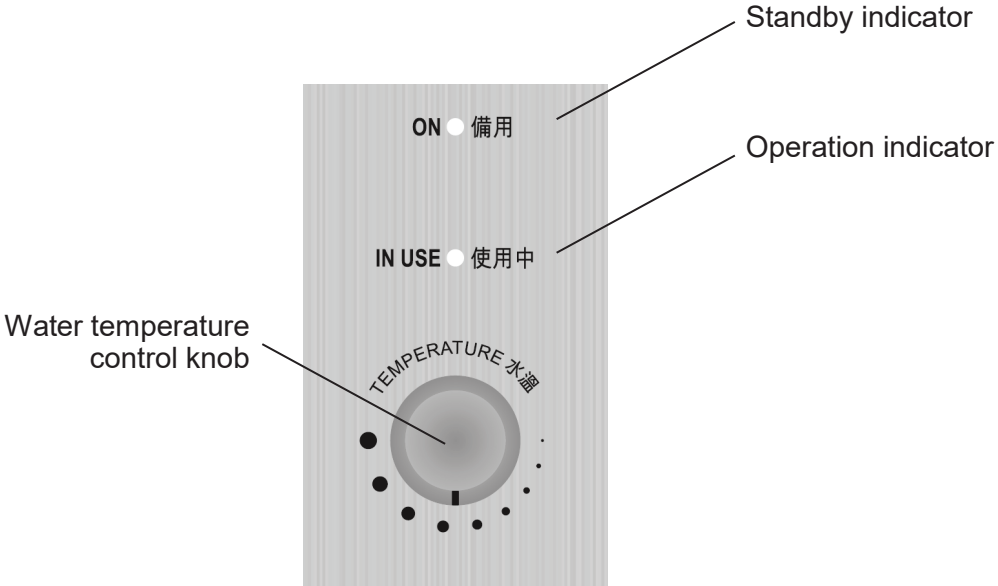

# Product Descriptions (ST13SD / ST16SD / ST20SD)

## ST13SD / ST16SD / ST20SD

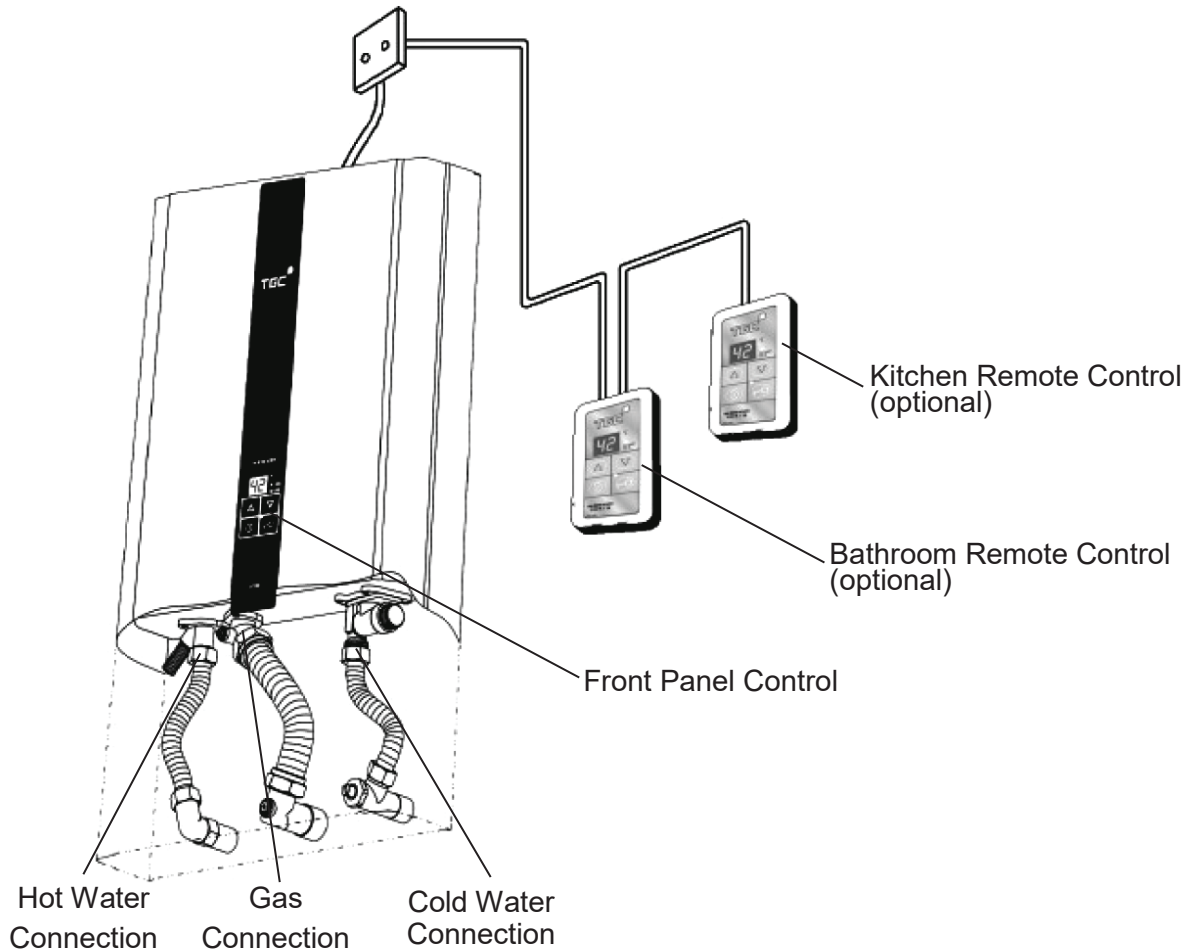

- Appliance can be connected to a maximum of 1 bathroom remote control (RC-929M) and 1 kitchen remote control (RC-929B).
- Additional bathroom remote control (RC-929M) and kitchen remote control (RC-929B) can be purchased optionally.

Front Panel Control



(with appliance)

Bathroom Remote Control

RC-929M



(optional to purchase)

Kitchen Remote Control

RC-929B



(optional to purchase)

# Product Descriptions (ST13SD / ST16SD / ST20SD)

## Front Panel Control

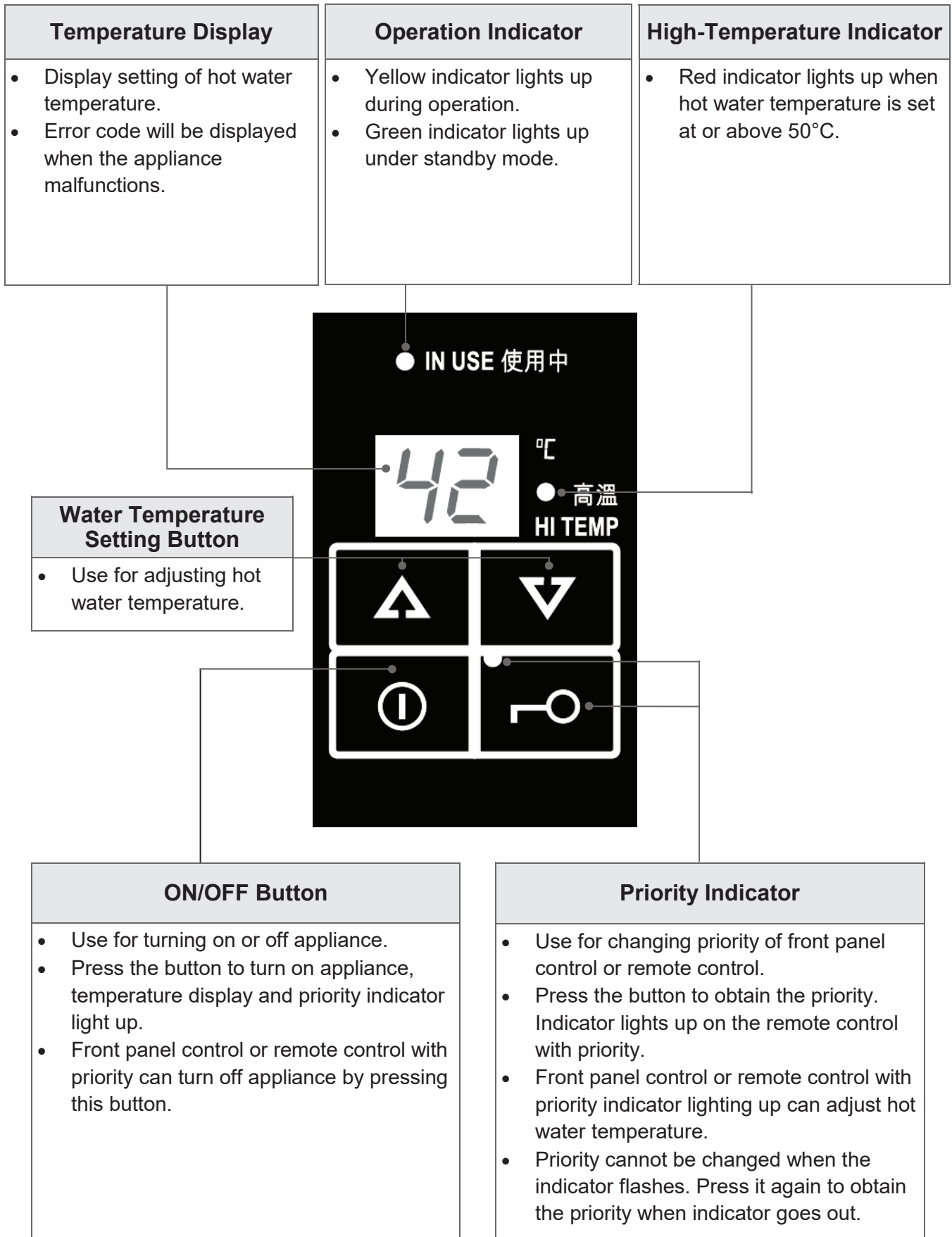

# Product Descriptions (ST13SD / ST16SD / ST20SD)

## Bathroom Remote Control (RC-929M)

Temperature Display	Operation Indicator	High-Temperature Indicator
<ul style="list-style-type: none"> <li>• Display setting of hot water temperature.</li> <li>• Error code will be displayed when the appliance malfunctions.</li> </ul>	<ul style="list-style-type: none"> <li>• Yellow indicator lights up during operation.</li> <li>• Green indicator lights up under standby mode.</li> </ul>	<ul style="list-style-type: none"> <li>• Red indicator lights up when hot water temperature is set at or above 50°C.</li> </ul>

**Water Temperature Setting Button**

- Use for adjusting hot water temperature.

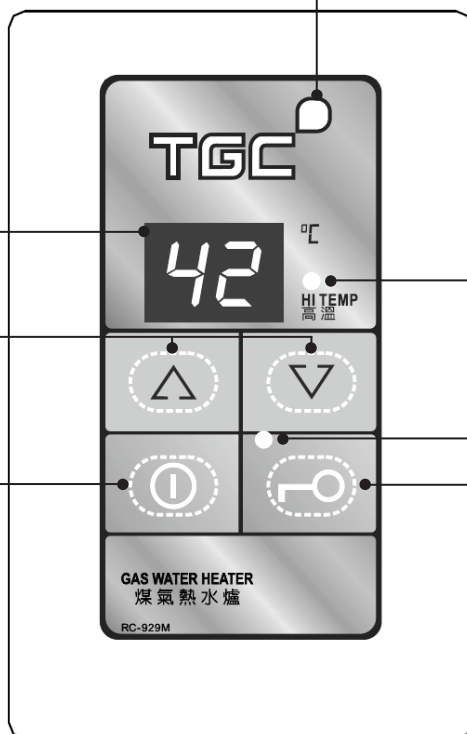

**ON/OFF Button**

- Use for turning on or off appliance.
- Press the button to turn on appliance, temperature display and priority indicator light up.
- Front panel control or remote control with priority can turn off appliance by pressing this button.

**Priority Indicator**

- Use for changing priority of front panel control or remote control.
- Press the button to obtain the priority. Indicator lights up on the remote control with priority.
- Front panel control or remote control with priority indicator lighting up can adjust hot water temperature.
- Priority cannot be changed when the indicator flashes. Press it again to obtain the priority when indicator goes out.

# Product Descriptions (ST13SD / ST16SD / ST20SD)

## Kitchen Remote Control (RC-929B)

Temperature Display	Operation Indicator	High-Temperature Indicator
<ul style="list-style-type: none"> <li>• Display setting of hot water temperature.</li> <li>• Error code will be displayed when the appliance malfunctions.</li> </ul>	<ul style="list-style-type: none"> <li>• Yellow indicator lights up during operation.</li> <li>• Green indicator lights up under standby mode.</li> </ul>	<ul style="list-style-type: none"> <li>• Red indicator lights up when hot water temperature is set at or above 50°C.</li> </ul>

Water Temperature Setting Button
<ul style="list-style-type: none"> <li>• Use for adjusting hot water temperature.</li> </ul>

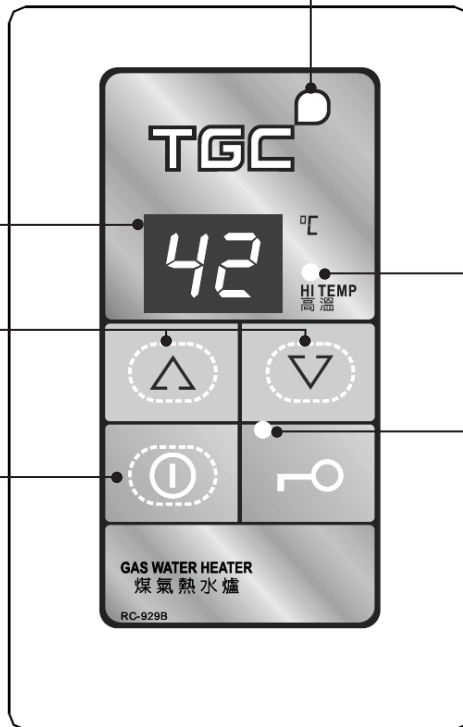

ON/OFF Button
<ul style="list-style-type: none"> <li>• Use for turning on or off appliance.</li> <li>• Press the button to turn on appliance, temperature display and priority indicator light up.</li> <li>• Front panel control or remote control with priority can turn off appliance by pressing this button.</li> <li>• Press the button to obtain the priority when priority indicator goes out.</li> </ul>

Priority Indicator
<ul style="list-style-type: none"> <li>• Press the button to obtain the priority. Indicator lights up on the remote control with priority.</li> <li>• Front panel control or remote control with priority indicator lighting up can adjust hot water temperature.</li> <li>• Priority cannot be changed when the indicator flashes.</li> </ul>



# Operating Instructions

## Caution

- When using the appliance for the first time or in the morning, the burner may not be ignited instantly because there may be some air remained inside the gas pipe. Please turn off the hot water tap and wait for 10 seconds, then turn on the hot water tap again to repeat the auto-ignition process.
- To prevent scalding:
  - check hot water temperature with hand first before taking shower. Do not direct hot water onto the head or body directly.
  - after using high-temperature hot water, the high-temperature hot water still remains inside the water pipework. To use relatively low-temperature hot water again, check the temperature with hand first and wait for suitable temperature before use.
- For ST13SD, ST16SD and ST20SD, high temperature indicator lights up when hot water temperature is set at 50°C or above. Be careful of using high-temperature hot water.
- In case of high water supply pressure, relatively loud sound of water flow may occur during the operation of appliance. This is a normal phenomenon.
- Turn off the cold water valve and the gas supply valve of appliance when it is not used for a long period of time.



Check hot water temperature with hand first

## First Time Usage of Appliance

Check the appliance by following instructions.

- Set the water temperature control knob to the location with the smallest indication or set the hot water temperature at 35°C. Fully turn on the hot water tap and turn off after confirming the hot water is running out.

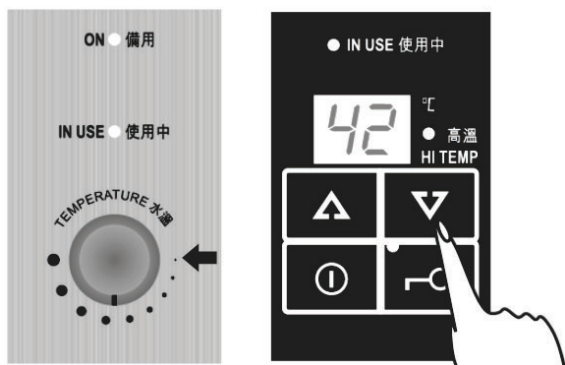

ST13SK/ST16SK

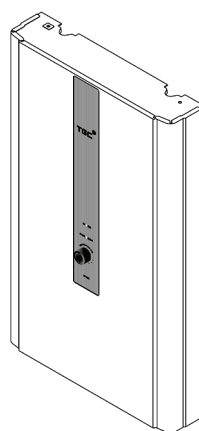

ST13SD/ST16SD/ST20SD

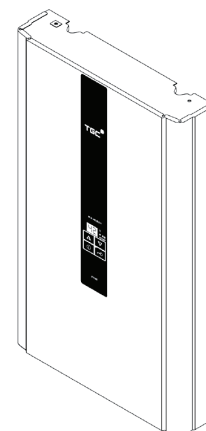

# Operating Instructions (ST13SK / ST16SK)

## Use of Appliance

### (1) Starting up appliance

- After turning on the power supply of appliance, standby indicator on the front control panel lights up. Appliance is under standby mode.

### (2) Setting hot water temperature

- Use the water temperature control knob to adjust hot water temperature.
- Rotate the control knob in clockwise direction to increase water temperature, while rotate in anti-clockwise direction to decrease water temperature.
- “ · ” is the lowest water temperature, “ ● ” is the highest water temperature.

### (3) Using hot water

- After turning on hot water tap, burner will be ignited automatically and hot water will be supplied. Yellow operation indicator lights up.
- Burner will be turned off when the hot water flow is lower than the minimum hot water flow. Therefore, hot water tap should not be turned on insufficiently. Otherwise, ignition may fail or the flame may be extinguished during use.

### (4) Stopping use of hot water

- Appliance stops operation immediately and hot water flow stops when the hot water tap is turned off. Operation indicator will go out.
- To use hot water again, repeat step (1) to (3).
- After turning off the power supply of appliance, all indicators go out.

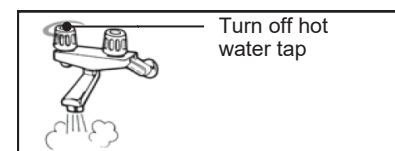
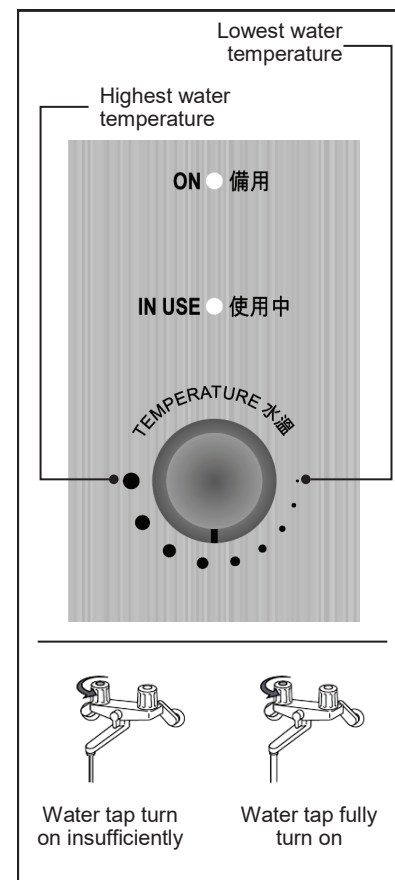
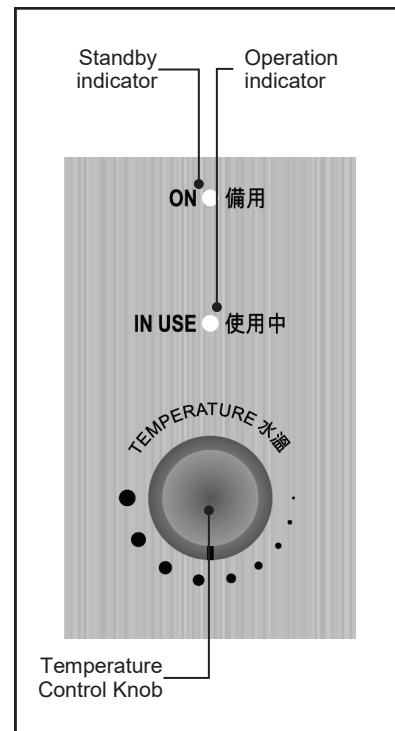

## Use of Appliance

### (1) Starting up appliance

- After turning on the power supply of appliance, press the ON/OFF button on front panel control/remote control.
- Temperature display and priority indicator light up. Appliance is under standby mode.
- Front panel control/remote control use for turning on appliance has the priority, and its priority indicator lights up. Priority cannot be changed when the priority indicator flashes.
- First time usage after new installation, default hot water temperature is 42°C.

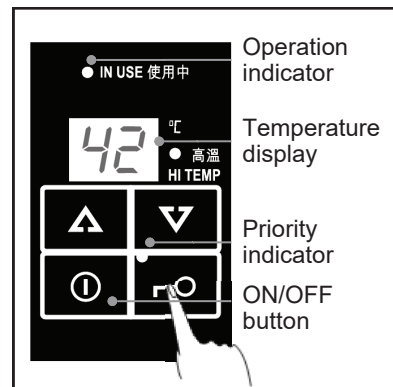

### (2) Setting hot water temperature

- Use front panel control/remote control with priority to adjust hot water temperature.
- Pressing “” and “” buttons to adjust hot water temperature. Pressing “” buttons to increase hot water temperature; while pressing “” buttons to decrease hot water temperature. Range of adjustment of hot water temperature is:

35 37 38 39 40 41 42 43 44 45 46 47 48 50 55 60

- 35°C is the lowest water temperature, 60°C is the highest water temperature.
- Set hot water temperature is displayed on the temperature display of all remote controls simultaneously.
- High temperature indicator lights up when hot water temperature is set at 50°C or above.

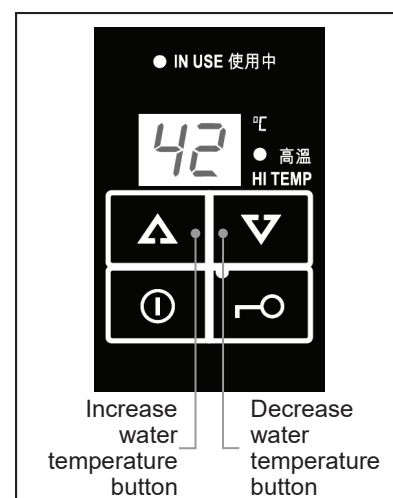

### (3) Using hot water

- After turning on hot water tap, burner will be ignited automatically and hot water will be supplied. Yellow operation indicator lights up.
- Burner will be turned off when the hot water flow is lower than the minimum hot water flow. Therefore, hot water tap should not be turned on insufficiently. Otherwise, ignition may fail or the flame may be extinguished during use.
- When appliance is in operation, hot water temperature can only be set at 48°C or below. If hot water temperature is set at 50°C or above, hot water temperature can only be decreased.

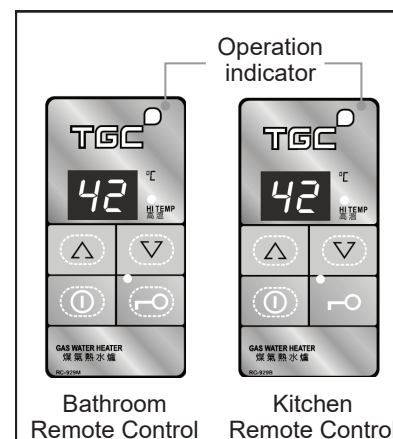

### (4) Stopping use of hot water

- Appliance stops operation immediately and hot water flow stops when the hot water tap is turned off. Operation indicator will go out.
- To use hot water again, repeat step (1) to (3).
- Front panel control or remote control with priority can turn off the appliance. Press the ON/OFF button, all displays and indicators go out.

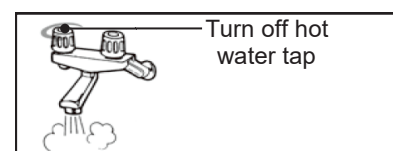
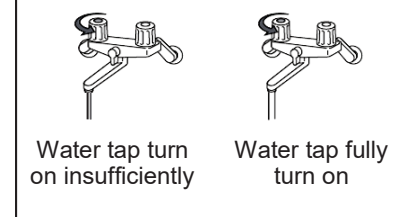

# Operating Instructions (ST13SD / ST16SD / ST20SD)

## Change of Priority (for installation of multiple remote controls)

- When one or more (maximum two) remote controls are installed, only the front panel control or remote control with priority can adjust the hot water temperature in order to avoid accidents, such as scalding.
- When the front panel control or bathroom remote control has the priority, its indicator lights up while the others will flash.
- When the kitchen remote control has the priority, its indicator lights up while the others will go out.
- Use the front panel control or bathroom remote control to change the priority to kitchen remote control.
- Priority cannot be changed when the priority indicator is flashing or the appliance is in operation.

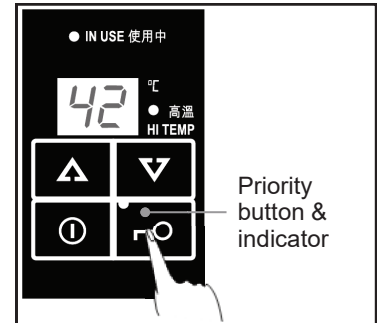

Priority button & indicator

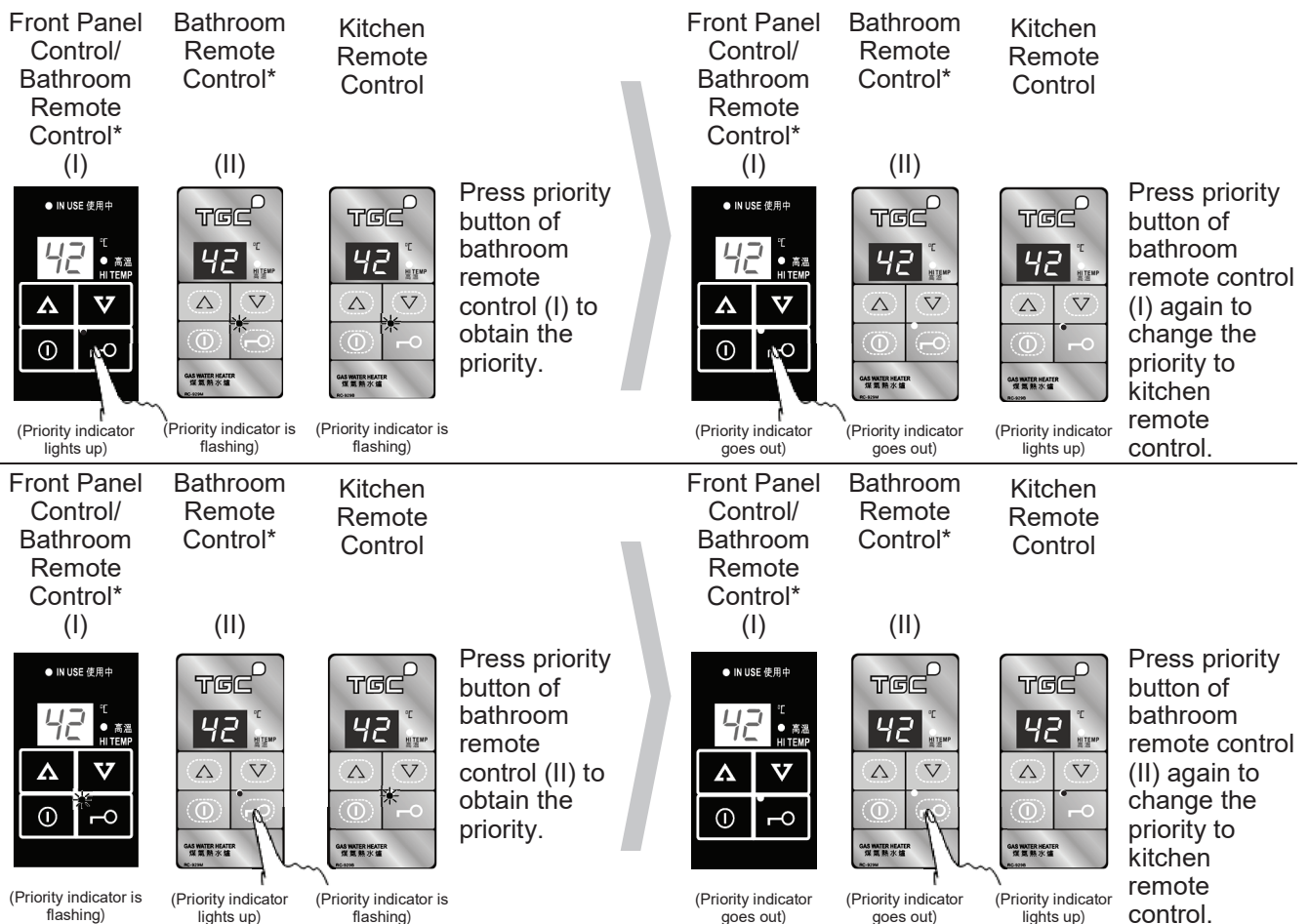

\* Bathroom remote control (I) and (II) are RC-929M. Kitchen remote control is RC-929B.

- Each front panel control or remote control can memorize the previous water temperature setting (maximum 48°C) with priority. When the priority is obtained, the previous water temperature setting will be displayed.
- When the appliance is in standby mode for more than 10 minutes, priority will be released. All priority indicators will go out thereafter. When appliance is used again, the appliance will provide hot water at the temperature set by the latest front panel control or remote control with priority.
- If hot water temperature is set at 50°C or above, water temperature setting will be returned to 48°C when the priority is released.

# Operating Instructions

## Safety Device

- **Flame failure safety device:** Using the flame rod sensor to monitor whether the combustion status is normal. When the flame fails, signal will be sent to the main controller to stop gas supply.
- **Remaining flame protection device:** If the flame still remains with the hot water temperature inside the heat exchanger has reached the design temperature after the hot water tap has been turned off, the device will stop the gas supply.
- **Over boiling protection device:** If the hot water temperature is higher than the design temperature, the device will activate and stop the operation of appliance.
- **Over heat protection device:** If the heat exchanger burns out or the temperature reaches the design temperature, the device will activate and stop the operation of appliance.
- **Over pressure protection device:** If the water pressure inside the appliance is over the design pressure value, the pressure relief valve located near the hot water outlet will be opened to release pressure. After reducing to the design pressure value, it will then be closed.
- **Water flow sensing device:** If the cold water flow becomes restricted or stopped, the device will activate and stop the operation of appliance.
- **Combustion fan revolution checking device:** Using the revolution sensor to monitor whether the revolution of fan is normal. When the revolution of fan deviates from the required speed, signal will be sent to the main controller to adjust the revolution.

Model	ST13SK / ST16SK	ST13SD / ST16SD / ST20SD
Design temperature of remaining flame protection device	100°C	
Design temperature of over boiling protection device	92°C	
Design temperature of over heat protection device	140°C	
Design pressure of over pressure protection device	Activate water pressure	2100kPa
	Deactivate water pressure	1700kPa

## Reminder of Adjusting Hot Water Temperature

- **ST13SK / ST13SD** is capable to deliver a flow rate of 12.8L/min (at 25°C temperature rise) hot water; **ST16SK / ST16SD** is capable to deliver a flow rate of 16.8L/min (at 25°C temperature rise) hot water; **ST20SD** is capable to deliver a flow rate of 19.8L/min (at 25°C temperature rise) hot water. To suit bathing purpose of different seasons, you may adjust hot water temperature through front panel control or remote control.
- In winter, there may be occasional extremely cold weather where supply water temperature is exceptionally low or required water flow is too high, hot water temperature of appliance may be relatively low. You may appropriately reduce the hot water flow by adjusting water faucet or shower tap to attain the suitable water temperature.
- In summer, there may be occasional extremely hot weather where supply water temperature is exceptionally high or hot water flow is too low, hot water temperature of appliance may be relatively high. You may adjust water faucet or shower tap to mix with cold water for attaining suitable water temperature.

## Maintenance

- (1) Never use solvents to clean the body of appliance. Please wipe the surface with a soft damp cloth, then dry with a soft cloth.
- (2) Remote control has waterproof design. However, avoid spraying water onto the remote control.
- (3) If the water flow at shower head is reduced, the holes of shower head may be blocked. It should be checked and cleaned.
- (4) It is necessary for the appliance to be inspected and maintained regularly so that it can be used safely and efficiently.

## Trouble Shooting

Safety devices will keep monitoring the operation status of appliance. If a fault occurs, ST13SK/ST16SK will notify the fault condition through the indicator signal; while a fault code will be displayed on the temperature display for ST13SD/ST16SD/ST20SD. Please describe the indicator signal or directly quote the code displayed when contacting customer service.

Model	Fault	Reasons of Failure	Remedy
ST13SK / ST16SK	Standby indicator is off.	Power supply is switched off	Switch on the power supply of appliance.
	Standby indicator is flashing.	1) Gas valve is closed	Turn on the gas valve.
2) Water heater has not been used for a long time		Turn on and then turn off the hot water tap for several times. Wait for 10 seconds each time.	
ST13SD / ST16SD / ST20SD	E1	1) Gas valve is close	Turn on the gas valve.
		2) Water heater has not been used for a long time	Turn on and then turn off the hot water tap for several times. Wait for 10 seconds each time.
		3) Ignition failure	After turning off the front panel control or remote control, check the gas meter valve and/or gas supply valve of appliance is fully turned on. Confirm the gas supply is normal without suspension. Turn on remote control again after confirmation. Turn on and then turn off the hot water tap for several times. Wait for 10 seconds each time. If the fault still persists, please contact customer service.
	E2	Flame detection failure	Please contact customer service.
	E3	Flame failure device activated	Please contact customer service.
	E4	Remaining flame safety device activated	Please contact customer service.
	E5	Overheating protection device activated	Please contact customer service.
	E6	Electricity failure and then resumed	Turn on and then turn off the hot water tap for several times. Wait for 10 seconds each time.
		Over boiling protection device activated	Please contact customer service.
	E7	Problem with combustion fan	Please contact customer service.
E8	Problem with temperature control unit	Please contact customer service.	
E9	60 minutes auto stop	Turn off and then turn on the hot water tap.	

In general cases, fault may be eliminated by turning off and then turning on the hot water tap again. If the fault cannot be eliminated, try to turn off the power supply and wait for 10 seconds before turning on the appliance again. If the fault still persists, please contact Towngas Customer Service Hotline on 2880 6988.

In cold and humid weather, cloudy mist may occasionally emerge from the flue terminal. The white mist is the condensate of water vapour in flue gases. This is a normal phenomenon.

# Trouble Shooting

## Issues of hot water supply and temperature

- |                                   |  |
|-----------------------------------|--|
| No hot water supplied             | <ul style="list-style-type: none"><li>• Check if the gas supply is normal and without suspension.</li><li>• Check if the water is running out from water tap normally.</li><li>• Check if the cold water filter is being blocked.</li><li>• Check if the power supply is normal.</li><li>• Fully turn on the main gas valve and/or gas supply valve of appliance.</li><li>• Fully turn on the cold water valve and/or hot water tap.</li><li>• After turning on the power supply of appliance, press the ON/OFF button on front panel control or remote control.</li></ul>   |
| No hot water supplied immediately | <ul style="list-style-type: none"><li>• After turning on the power supply, press the ON/OFF button on front panel control or remote control.</li><li>• There is a distance between the appliance and the hot water tap, therefore, hot water cannot be supplied immediately.</li></ul>   |
| Hot water flow is fluctuated      | <ul style="list-style-type: none"><li>• When the appliance is supplying hot water to a water tap with another water tap using hot water at the same time, the hot water flow will be reduced. Depending on the conditions of water supply pressure and pipework, hot water flow may be reduced suddenly or with a discontinued water flow situation. After the conditions of water supply pressure and pipework are stabilized, hot water flow will be stable.</li><li>• Due to the differences in product features of water tap, variation of hot water flow may be special feature of particular product. For example: hot water flow will be higher at the beginning and water flow will be stabilized afterward.</li></ul> |
| Hot water temperature is too high | <ul style="list-style-type: none"><li>• Fully turn on the cold water valve and/or hot water tap.</li><li>• Check if the set hot water temperature is appropriate.</li><li>• In summer, there may be occasional extremely hot weather where supply water temperature is exceptionally high or required water flow is too low, hot water temperature of appliance may be relatively higher. You may adjust water faucet or shower tap to mix with cold water for attaining suitable water temperature.</li></ul>   |
| Hot water temperature is too low  | <ul style="list-style-type: none"><li>• Fully turn on the gas meter valve and/or gas supply valve of appliance.</li><li>• Check if the set hot water temperature is appropriate.</li><li>• In winter, there may be occasional extremely cold weather where supply water temperature is exceptionally low or required water flow is too high, hot water temperature of appliance may be relatively less. You may appropriately reduce the hot water flow by adjusting water faucet or shower tap to attain the suitable water temperature.</li></ul>  |

# Trouble Shooting

## Issues of hot water supply and temperature

- |  |  |
|--|--|
| Hot water temperature is unstable              | <ul style="list-style-type: none"><li>• Fully turn on the main water supply valve to ensure sufficient water pressure.</li><li>• Increase hot water flow of mixing-type faucet to avoid the hot water flow lower than the minimum hot water flow that burner will be turned off.</li></ul>   |
| Unable to adjust hot water temperature setting | <ul style="list-style-type: none"><li>• Confirm the using front panel control or remote control has the priority and check if the priority indicator lights up.</li><li>• When appliance is in operation, hot water temperature can only be set to 48°C or below. If hot water temperature is set at 50°C or above, hot water temperature can only be decreased.</li></ul> |

## Issues of front panel control, remote control and appliance operation

- |  |   |
|--|---|
| ON/OFF indicator does not light up                                       | <ul style="list-style-type: none"><li>• Check if the power supply is normal.</li><li>• After turning on the power supply of appliance, press the ON/OFF button on front panel control or remote control.</li></ul>  |
| Hot water temperature setting change automatically                       | <ul style="list-style-type: none"><li>• When the appliance is in standby mode for more than 10 minutes, priority will be released. If hot water temperature is set at 50°C or above, hot water temperature will be returned to 48°C when the priority is released.</li></ul>  |
| Fan keeps operating without use of hot water                             | <ul style="list-style-type: none"><li>• After the burner is closed, combustion fan will keep operating for a short period of time. This is a normal phenomenon.</li></ul>   |
| Flame failure during usage   | <ul style="list-style-type: none"><li>• Fully turn on the gas meter valve and/or gas supply valve of appliance.</li><li>• Check if the gas supply is normal and without suspension.</li><li>• Fully turn on the cold water valve and/or hot water tap.</li><li>• Check if the water is running out from water tap normally.</li></ul> |
| Cloudy mist emerges from flue terminal                                   | <ul style="list-style-type: none"><li>• In cold and humid weather, white mist is the condensate of water vapour in flue gases. This is a normal phenomenon.</li></ul>   |
| Hot water turns milky with a cloudy status                               | <ul style="list-style-type: none"><li>• Dissolved air in water is released as bubbles when heated. This is normal phenomenon.</li></ul>   |
| Water is discharged momentarily from the outlet of pressure relief valve | <ul style="list-style-type: none"><li>• If the water pressure inside the appliance is over the design pressure value, the pressure relief valve located near the hot water outlet will be opened to release pressure. After reducing to the design pressure value, it will then be closed.</li></ul>                                  |



# Specifications

Model		ST13SK		ST13SD				
Sales Code		ST13SK-W	ST13SK-WH	ST13SD-W	ST13SD-G	ST13SD-WH	ST13SD-WL	
Basic Specifications	Appliance Type	Fan Draught Room-sealed Type						
	Installation Type	Wall-mount Type						
	Flue Type	Back Flued Type						
	Dimensions - W x H x D (mm)	360 x 587.5 x 78	360 x 670 x 78	360 x 587.5 x 78	360 x 587.5 x 78	360 x 670 x 78	360 x 670 x 78	
	Weight (kg)	16						
	Gas Type	Hong Kong Town Gas						
	Gas Supply Pressure (kPa)	1.5						
	Gas Connection	M28 x P1.5 Threads						
	Water Pipework Connections	Cold Water	1/2" BSP					
		Hot Water	1/2" BSP					
	Power Supply & Signal Connections	Power	220V / 50Hz					
		Signal Cable	DC 12V (2 Pin Cable)					
	Ignition Type	Automatic Spark Ignition						
	Rated Heat Input (kW)	Maximum	27.9					
		Minimum	7.6					
	Power Consumption (W)	65						
Level of Water-proof	Body	IPX4						
	Remote Control	IPX4						
Operation System	Capacity of Hot Water Supply with 25°C Temperature Rise (L/min)	3.5 to 12.8						
	Amount of Hot Water Supply Range (L/min)	3.0 to 12.8						
	Minimum Hot Water Flow (L/min)	3.0						
	Minimum Operation Water Pressure (kPa)	20						
	Range of Normal Operation Water Pressure (kPa)	70 to 500						
	Range of Hot Water Temperature (°C)	/	35, 37 to 48, 50, 55 & 60					
Safety Devices	Flame Failure Safety Device	Flame Rod Sensor						
	Remaining Flame Protection Device	Bi-metal Switch (100°C)						
	Over Boiling Protection device	Thermistor (92°C)						
	Overheat Protection Device	Thermal Fuse (140°C)						
	Over Pressure Protection Device	Water Pressure Relief Valve (ON: 2100kPa)						
	Water Flow Sensing Device	Water Flow Sensor						
	Combustion Fan Revolution Checking Device	Revolution Sensor						
	Over Electrical Current Protection Device	Fuse (5A)						
Control & Accessories	Front Panel Control Unit	Rotary Knob		Temperature Display & Soft Button				
	Remote Control (Wired) ※ Optional to purchase	/		/				
				※ RC929-M / RC-929B				

The appliances comply with Hong Kong Electrical Products (Safety) Regulation.

# Specifications

Model		ST16SK	ST16SD		ST20SD		
Sales Code		ST16SK-W	ST16SD-W	ST16SD-G	ST20SD-W	ST20SD-G	ST20SD-WH
Basic Specifications	Appliance Type	Fan Draught Room-sealed Type					
	Installation Type	Wall-mount Type					
	Flue Type	Back Flued Type					
	Dimensions - W x H x D (mm)	360 x 587.5 x 78	360 x 587.5 x 78	360 x 587.5 x 78	360 x 587.5 x 78	360 x 587.5 x 78	360 x 670 x 78
	Weight (kg)	17			22		
	Gas Type	Hong Kong Town Gas					
	Gas Supply Pressure (kPa)	1.5					
	Gas Connection	M28 x P1.5 Threads					
	Water Pipework Connections	Cold Water	1/2" BSP				
		Hot Water	1/2" BSP				
	Power Supply & Signal Connections	Power	220V / 50Hz				
		Signal Cable	DC 12V (2 Pin Cable)				
	Ignition Type	Automatic Spark Ignition					
	Rated Heat Input (kW)	Maximum	36.6			43.2	
		Minimum	9.8			7.6	
	Power Consumption (W)	77			77		
Level of Water-proof	Body	IPX4					
	Remote Control	IPX4					
Operation System	Capacity of Hot Water Supply with 25°C Temperature Rise (L/min)	4.5 to 16.8			3.5 to 19.8		
	Amount of Hot Water Supply Range (L/min)	3.0 to 16.8			3.0 to 19.8		
	Minimum Hot Water Flow (L/min)	3.0					
	Minimum Operation Water Pressure (kPa)	20					
	Range of Normal Operation Water Pressure (kPa)	70 to 500					
	Range of Hot Water Temperature (°C)	/	35, 37 to 48, 50, 55 & 60				
Safety Devices	Flame Failure Safety Device	Flame Rod Sensor					
	Remaining Flame Protection Device	Bi-metal Switch (100°C)					
	Over Boiling Protection device	Thermistor (92°C)					
	Overheat Protection Device	Thermal Fuse (140°C)					
	Over Pressure Protection Device	Water Pressure Relief Valve (ON: 2100kPa)					
	Water Flow Sensing Device	Water Flow Sensor					
	Combustion Fan Revolution Checking Device	Revolution Sensor					
	Over Electrical Current Protection Device	Fuse (5A)					
Control & Accessories	Front Panel Control Unit	Rotary Knob	Temperature Display & Soft Button				
	Remote Control (Wired) ※ Optional to purchase	/	/ ※ RC929-M / RC-929B				

The appliances comply with Hong Kong Electrical Products (Safety) Regulation.





香港中華煤氣有限公司  
**The Hong Kong and China Gas Company Limited**