

# SIMPA

座枱煮食爐  
HOTPLATE

型號     UZH1S / UZH1SL  
Model    :    UZH2S / UZH2SL

使用說明書  
Operating Instructions

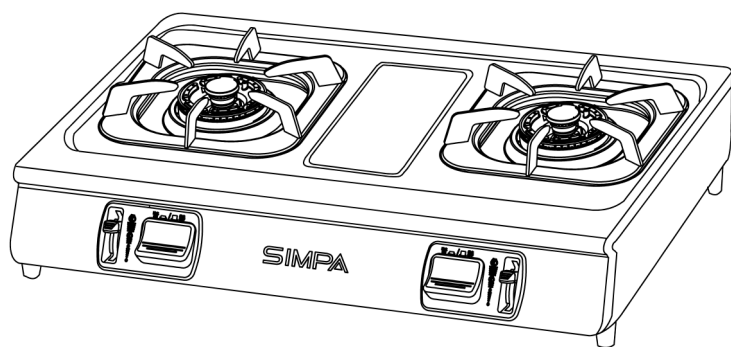

UZH2S / UZH2SL

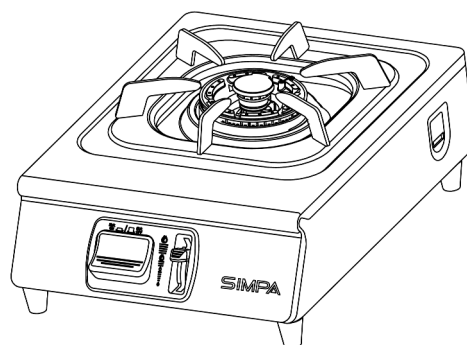

UZH1S / UZH1SL

香港煤氣 / 石油氣適用  
For Hong Kong Town Gas / LPG

重要安全指示 .....	第 1 頁
產品介紹 .....	第 3 頁
安裝指示 .....	第 4 頁
操作指示 .....	第 5 頁
保養 .....	第 6 頁
故障處理方法 .....	第 7 頁
規格 .....	第 8 頁

## 注意!

根據香港氣體安全條例，任何氣體裝置工程，包括爐具和接駁喉管的安裝，必須由註冊氣體裝置技工執行，而該技工已於相關的氣體工程類別註冊及受聘於註冊氣體工程承辦商。

## 重要安全指示

感謝閣下選用簡柏產品！以下指示對氣體煮食爐的安全操作十分重要，請詳細閱讀，如有查詢和服務要求，請聯絡煤氣公司 24 小時客戶服務熱線 2880 6988。

### 安裝

1. 使用認可印有機電工程署批准標記 (例如: 機電工程署批准 EMSD APPROVAL GTXXXX) 的氣體接駁喉管連接爐具或使用機電工程署接納的其他恰當方法。
2. 爐具周圍和下方不可放置可燃物品，如紙張、塑膠等，與可燃物料距離須保留 150 毫米以上。
3. 爐具必須安裝在空氣流通之房間內。

### 使用

1. 當懷疑洩漏氣體時，將窗戶打開，以及關閉煤氣錶閥。切勿操作任何電器或電掣開關。切勿在現場使用任何電話。在現場以外的地方，致電煤氣公司緊急事故熱線 2880 6999。
2. 請參照說明書內指引正確使用爐具。
3. 爐具只供家用，切勿用於商業用途。
4. 除煮食外，切勿使用爐具作其他用途，例如烘乾衣物。
5. 使用爐具前，請開啟窗戶及排氣系統。
6. 不可讓兒童使用爐具。
7. 切勿讓爐具在無人看管下運作。
8. 切勿在爐頭加上錫紙碟，這會引致燃燒問題。
9. 使用前，確保爐頭蓋、爐碟和爐架擺放正確，沒有傾斜。
10. 切勿放置超過 10 公斤的重量在爐架上。
11. 爐架很重，切勿掉下。
12. 請確保使用時火焰平均。
13. 注意爐面、爐頭及爐架的高溫。
14. 切勿使用直徑超過 300 毫米的平底煮食器皿，避免溫度過高而造成燙傷及影響爐具的使用壽命。
15. 使用細小器皿時，請將火力調低，避免火焰超出煮食器皿底部。
16. 請確保器皿穩定地放在爐架上，如器皿容易滑動，必須緊握它。
17. 燒開水或煮湯時，注入的水量連湯料不可超過器皿容量 3 分之 2，溢出液體會影響燃燒和損壞爐具。
18. 烹調時，請儘量蓋上鍋具。而鍋具的手柄亦應轉向適當位置，避免受熱或碰撞。
19. 請勿在爐具附近使用噴霧產品。
20. 使用後，應將所有開關按鈕設於關閉位置。
21. 經常清潔爐頭蓋以保持爐頭火孔暢通，如滾瀉食物及汁液，應在爐具冷卻後儘快作出妥善清潔。
22. 如爐具出現異常聲響，應先關火。在爐具冷卻後，檢查及放好爐頭蓋。若問題持續，聯絡煤氣公司進行檢查。

### 保養

1. 定期檢查氣體喉管狀況，確保沒有扭結或裂縫，若發現損壞，請聯絡煤氣公司更換喉管。
2. 讓爐具完全冷卻後，才可進行清潔。
3. 清潔爐具時，應穿上保護手套，避免接觸爐具內部，防止割傷。
4. 清洗爐頭蓋後，用乾布將爐頭蓋完全抹乾，爐頭火孔不可留有水份，以免影響燃燒。
5. 使用前和使用後，注意爐頭的狀況和清潔。以下不正常狀況會產生燃燒不良，進而引致爐具損壞。請確保採取相應措施，糾正有關問題。

不正常情況	處理措施
爐頭蓋變形	聯絡煤氣公司更換零件。
爐頭蓋傾斜	將爐頭蓋重新放好，不可傾斜。
爐頭火孔被水堵塞	用布將爐頭蓋抹乾後，重新放好。
爐頭火孔被污積堵塞	用溫和洗滌劑和刷子清潔爐頭蓋。用布將爐頭蓋抹乾後，重新放好。

## 產品介紹

這爐具是專為香港各式煮食需要而設計，配備優質不鏽鋼面板，機身纖巧，其品質、安全性和效能都表現卓越，而且可靠耐用，操作簡單，清理容易。

產品備有熄火安全裝置，如爐火意外熄滅或因爐頭阻塞而引致不正常燃燒，會自動關閉氣體，確保安全。

### 部件名稱

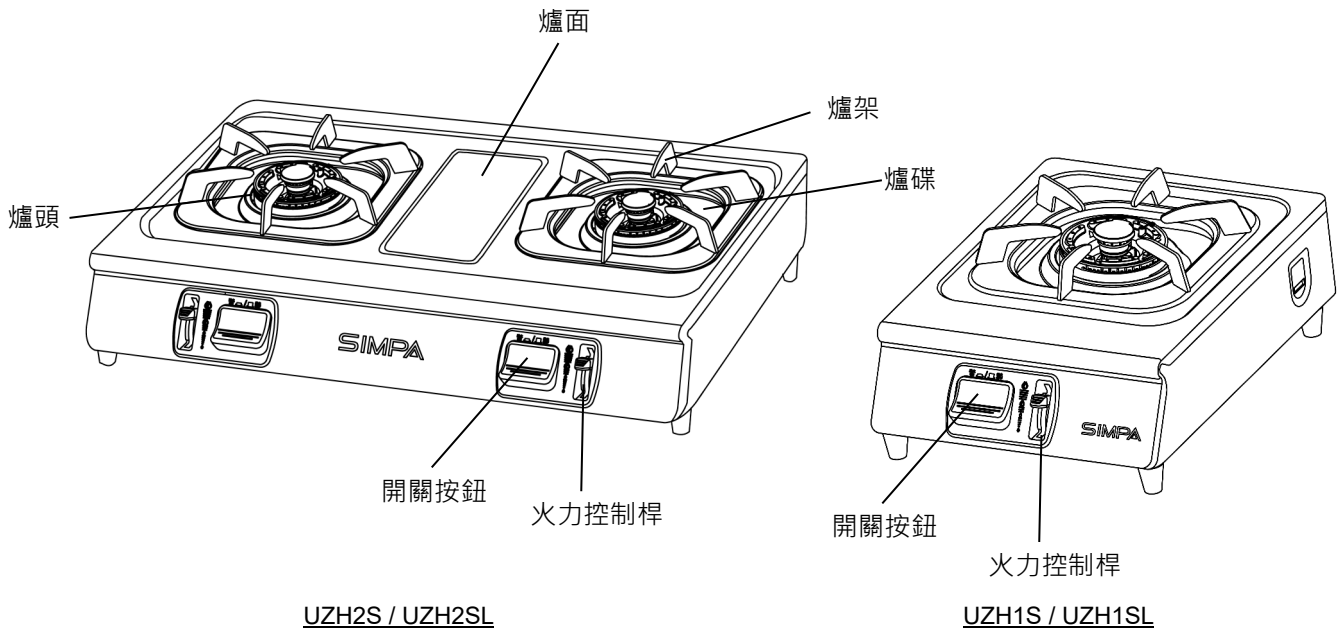

### 爐頭部件

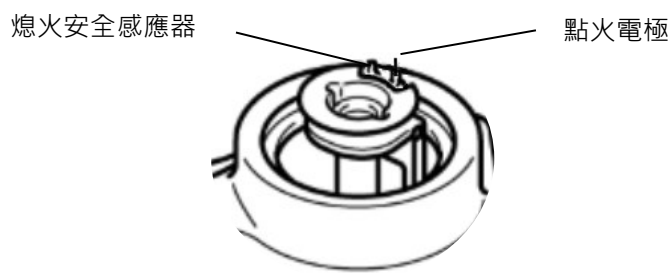

### 特點包括:

- \* 強勁雙環爐頭，滿足各式煮食需要。
- \* 按鈕式火花點火，推桿火力控制，操作簡單靈活。
- \* 銅合金製爐頭蓋，表面加上耐高溫塗層，槽式火孔，堅固耐用，清理容易。
- \* 熄火安全裝置和防高溫保護裝置，確保安全。

## 安裝指示

- \* 爐具須放置在穩固之平面上。
- \* 以批准的氣體軟喉接駁爐具。
- \* 氣體接駁軟喉可置於爐底下，但必須平放貼灶台，避免翹起觸及爐頭底部。
- \* 使用前正確擺放爐架和爐頭蓋。

### 1. 爐架

- 爐架底定位針插入爐面通定位孔。
- 爐架必須平放，不可傾斜。

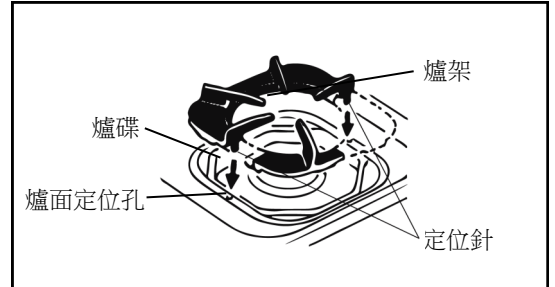

### 2. 爐頭

- 爐頭由外環爐頭蓋、芯火爐頭蓋和爐頭座組成。
- 爐頭蓋必須平放，不可傾斜。
- 若爐頭蓋未放置正確，有機會導致以下情況：
  - 無法點火
  - 火焰不均和回火會導致不完全燃燒、一氧化碳中毒和爐頭變形。
  - 火焰進入爐具內，會導致損毀。

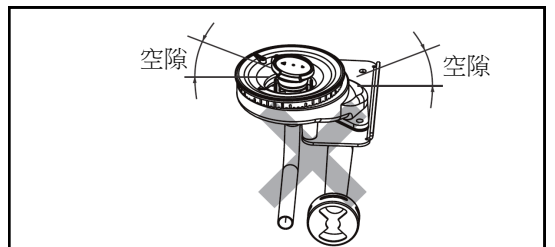
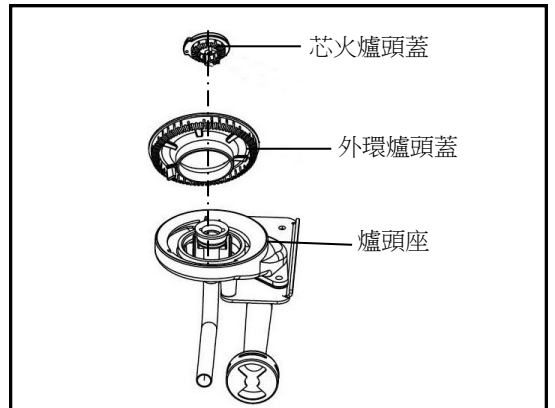

### 3. 爐碟

擺放爐碟時，必須平放，不可傾斜。

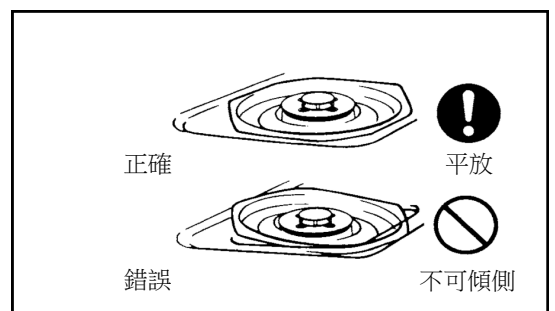

## 操作指示

### 1. 點火

完全按下按鈕，火花點著爐頭後鬆開按鈕，爐火會維持。





若爐火不能維持，按一下按鈕返回熄火位置，等待 1 分鐘，讓氣體散走，然後重新點火。



### 2. 火力調節

請慢慢推火力控制桿。火力可用火力控制桿加以調節。

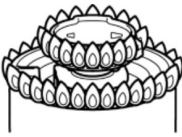
請按照鍋的大小調節火力。火力過大會燒壞鍋子的把手，這會導致手部燙傷。

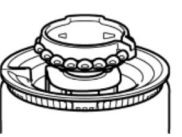
火力控制桿位置			
爐火狀況			
芯火	最大	最大	小
外環火	最大	熄滅	熄滅

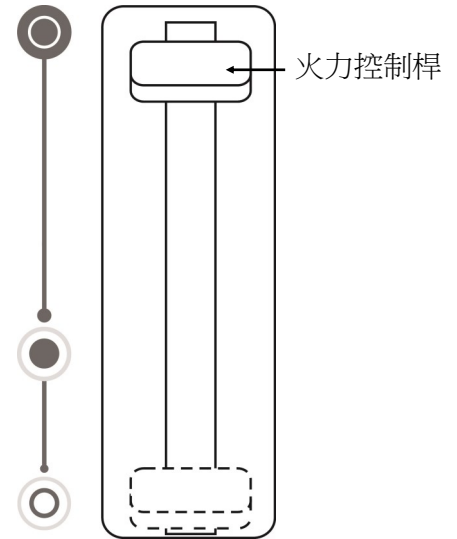

### 3. 熄火

按一下按鈕，按鈕會回到關的位置。

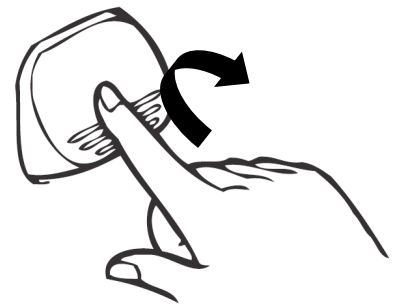

### 4. 爐火意外熄滅

如爐火意外熄滅，按一下按鈕，將它返回關閉位置。確保爐頭是清潔後才重新點火。

如爐頭火孔被堵塞，待爐頭冷卻後，進行清理，抹乾後，重新點火。

注意：待爐具完全冷卻後，才可進行任何保養及清潔。清潔時，亦應配戴手套保護雙手。

為妥善保養爐具，遵照以下指示定期清潔爐具：

- 請勿使用蒸氣清潔爐具；
- 使用適當非研磨及非腐蝕性的清潔劑清潔金屬及搪瓷部份，避免使用含氯清潔劑（如漂白劑）；
- 避免酸性或鹼性物質（如醋、鹽水、檸檬汁）殘留在爐具；
- 煮食時如有液體溢出，應待爐具冷卻後儘快清理；
- 定期使用暖水及清潔劑清洗爐頭蓋，將污漬去除，並保持爐頭火孔暢通；
- 清潔後須完全抹乾爐頭蓋，並確定爐頭火孔未被堵塞；
- 將爐頭蓋正確放回爐頭座，不可傾斜或反轉；
- 定期檢查熄火安全感應器和點火電極，如有污物黏附，用軟刷將污物去除。



## 故障處理方法

有些故障是可以由使用者處理，但如採取以下補救措施後仍然無效，請致電煤氣公司客戶服務熱線 2880 6988。

故障	原因	處理方法
1. 沒有點火	點火電極濕了。	以乾布抹乾點火電極。
	點火電極有污穢。	清理點火電極。
	電池已耗盡。	更換電池。
	電池電極擺放錯誤。	重新放好電池。
2. 沒有火焰	仍未開啟煤氣錶閥及 / 或爐具供氣閥。	完全開啟煤氣錶閥及 / 或爐具供氣閥。
	錫紙阻塞爐頭。	拿去錫紙。
3. 不能保持爐火	未按盡開關按鈕。	按盡開關按鈕，並保持按下數秒。
	熄火安全感應器有污穢	清理熄火安全感應器
4. 使用中熄火	用小火時被風吹熄。	等待 1 分鐘，重新點火。
5. 黃火	爐頭有污穢。	以暖水和清潔劑清洗爐頭蓋，將它抹乾和放好後，重新點火。
6. 火焰不穩定	爐頭蓋擺放不正確。	冷卻後，重新放好爐頭蓋，再點火。
7. 使用中出現異常聲音	爐頭蓋擺放不正確。	將爐具熄火，待爐具冷卻後，重新放好爐頭蓋，重新點火。
8. 關火時出現響聲	殘留在爐頭內氣體瞬間燃燒。	正常現象。

## 規格

型號		UZH1S	UZH1SL	UZH2S	UZH2SL
氣體種類		香港煤氣	香港石油氣	香港煤氣	香港石油氣
爐頭數目		1	1	2	2
額定熱負荷 (千瓦)	總	5.8	4.5	11.5	8.8
	左爐頭	-	-	6.0	4.5
	右爐頭	-	-	6.0	4.5
供氣壓力(千帕)		1.5	2.9	1.5	2.9
氣體接頭		1/2 吋 英制陽螺紋	3/8 吋 膠喉咀	1/2 吋 英制陽螺紋	3/8 吋 膠喉咀
機身尺寸 (毫米)	高(至爐面)	128		128	
	寬	290		700	
	深(爐身)	389		389	
重量(千克)		3.8		8.0	
點火裝置		快易電子點火系統			
熄火安全裝置		熱電偶式			
電力供應		D 型電池(1 枚) 1.5 伏特			

Important Safety Instructions.....	P. 10
Product Description .....	P. 12
Installation Instructions.....	P. 13
Operating Instructions .....	P. 14
Maintenance.....	P. 15
Troubleshooting.....	P. 16
Specifications .....	P. 17

## **Attention!**

According to the Gas Safety Ordinance of Hong Kong, any gas installation works including the installation of appliances and connection tubing, must be undertaken by registered gas installers who are registered for that appropriate classes and be employed by registered gas contractors.

## Important Safety Instructions

Thank you for choosing SIMPA products! The following instructions are very important to safety operation of gas hotplate. Please read through them carefully. Please contact Towngas 24-hour Customer Service Hotline on 2880 6988 for enquiry and services.

### **Installation**

1. Use approved gas tubing bearing EMSD approval marking (such as: 機電工程署批准 EMSD APPROVAL GTXXXX) for connection to appliance or other appropriate methods accepted by EMSD.
2. Do not put any combustible materials, e.g. paper and plastic near or under appliance. The appliance should be installed with a distance more than 150mm distance away from combustible materials.
3. Install the appliance in a well-ventilated room.

### **Operation**

1. In case of suspected gas leak, open windows and shut off gas meter valve. Do not operate any electric appliances or switches. Do not use any phones on site. Contact Towngas Emergency Hotline on 2880 6999 with a phone outside the premises.
2. Please use the appliance properly according to the operating instructions.
3. This appliance is designed for domestic use only. Do not use it for commercial purposes.
4. Do not use the appliance for any purposes other than cooking, e.g. drying clothes.
5. Open windows and turn on ventilation system before operating the appliance.
6. Do not allow kids to use appliance.
7. Do not leave operating appliance unattended.
8. Do not add aluminum discs to burners. This will incur combustion problem.
9. Before use, ensure the burner caps, drip pans and pan supports are in correct position and are not tilted.
10. Do not put weight exceeding 10kg on pan support.
11. Pan support is heavy. Do not drop it.
12. Make sure that flame condition is uniform during operation.
13. Heed high temperature of top plate, burner and pan support.
14. Do not use flat bottom pot of diameter larger than 300mm to avoid the risk of scald by high temperature and reduction of service life of appliance.
15. When using small utensil, reduce flame power that flame does not escape from utensil bottom.
16. Ensure stability of utensil resting on pan support. Hold utensil firmly if it slips easily.
17. Do not fill water including soup ingredients over two-thirds of utensil volume when boiling water or soup. Spilled liquid of boiling will affect combustion and damage the appliance.
18. Always use pots with covers and make sure that the handles of the pots are correctly positioned to avoid heating and collision of handles.
19. Do not use sprays near the appliance.
20. ON / OFF buttons should be pressed to off position after use.
21. Clean burner caps regularly to ensure smooth passage of burner flame holes. In case of spillage of food or liquid, clean appliance properly once it cools down.
22. If abnormal noise is observed, turn off flame. Check and place burner caps correctly after appliance cools down. Contact Towngas Company for inspection if problem persists.

## Important Safety Instructions

### Maintenance

1. Check condition of gas hose regularly. Ensure that it is free from kink or crack. Contact Towngas Company to replace it if damage is found.
2. Allow the appliance to cool down completely before cleaning.
3. Wear gloves to protect the hands when cleaning the appliance. Avoid to touch interior of appliance to prevent cut injury.
4. Dry burner caps completely with dry cloth after washing. Burner flame holes must be free from water lest combustion is affected.
5. Before and after use, notice the condition and cleanliness of burner. The following abnormal conditions will incur abnormal combustion and thus damage of the appliance. Ensure undertaking measures to rectify the problem accordingly.

<b>Abnormal Condition</b>	<b>Handling Measure</b>
Burner caps are deformed.	Contact Towngas Company to replace the parts.
Burner caps are tilted.	Place burner caps properly. Burner caps must not be tilted.
Burner flame holes are blocked by water.	Dry burner caps with cloth and place them properly.
Burner flame holes are blocked by dirt.	Clean burner caps with mild detergent and brush. Dry burner caps with cloth and place them properly.

## Product Description

The appliance is designed to meet versatile cooking needs in Hong Kong. It is equipped with fast-easy electronic ignition system. Powerful flame with independent simmer flame is suitable for Chinese cooking. It performs exceedingly in quality, safety and performance and is reliable, durable, simple to use and easy to clean.

It is equipped with flame failure safety device. In case of unexpected flame extinguishment or abnormal combustion due to burner blockage, gas is shut off automatically to ensure safety.

### Component Description

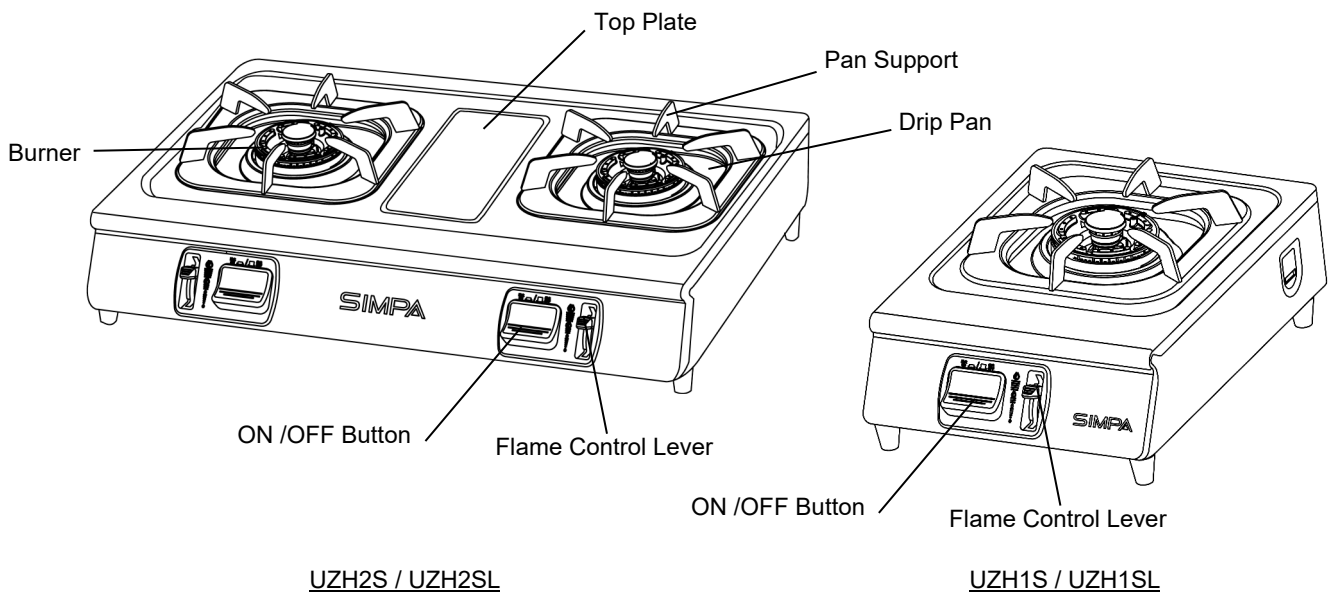

### Burner Parts

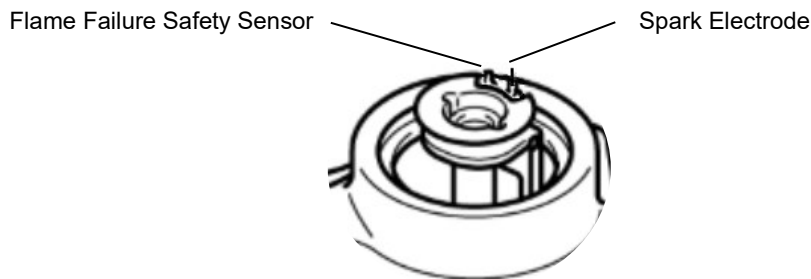

Features include:

- Powerful burner for versatile cooking needs.
- Push-button spark ignition and lever flame control for easy and flexible operation.
- Brass burner caps with thermal resistant coating and slot type flame holes for durability and easy cleaning.
- Flame failure safety device and overheat appliance protection device for safety.

## Installation Instructions

- Place the appliance on a stable and level surface.
- Connect the appliance with approved flexible gas hose.
- Gas hose can be placed under appliance. However, it must be placed horizontally on bench and avoid tilting up to touch burner bottom.
- Place pan supports and burner caps correctly before use.

### 1. Pan Support

Fit pan support bottom guide pins into top plate guide holes.

Place the pan support horizontally and never tilt it.

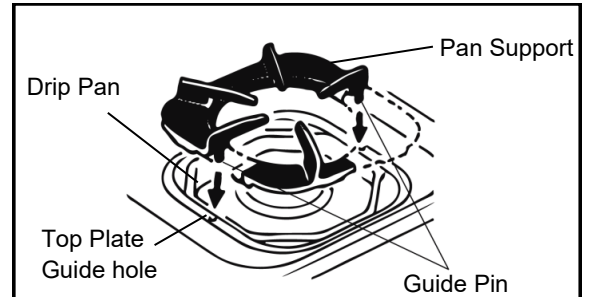

### 2. Burner

- Burner consists of outer ring burner cap, simmer burner cap and burner base.
- Place burner caps horizontally and never tilt them.
- If burner caps are not placed properly, it may cause the following problems:
  - No ignition.
  - It may cause incomplete combustion, risk of carbon monoxide poisoning and burner deformation.
  - Flame may get into appliance and damage it.

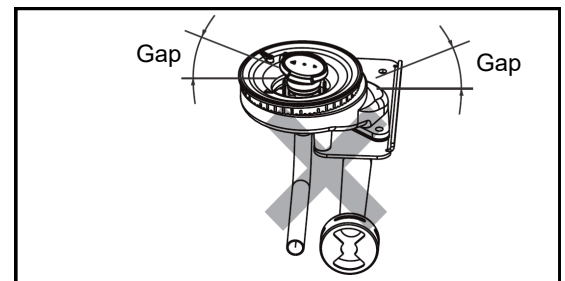
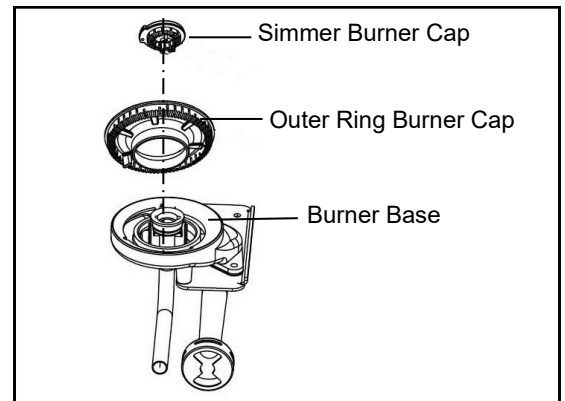

### 3. Drip Pan

Place drip pan horizontally and never tilt it.

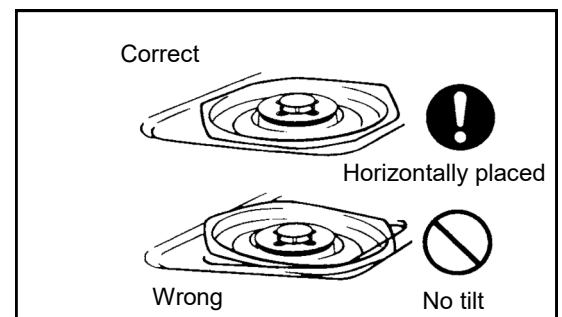

# Operating Instructions

## 1. Ignition

Fully press ON/OFF button. Release button after spark ignites burner. Flame will persist.

If flame does not persist, press button once to turn off. Wait for 1 minute to allow gas dispersion. Then repeat ignition procedure.



## 2. Flame Adjustment

Please move flame control lever slowly. Flame can be adjusted by moving flame control lever.

Adjust flame power according to the size of pot. Excessive flame power may scorch handle of cooking utensil. This will incur scald of hand.

Flame Control Lever Position			
Flame Condition			
Simmer Flame	Maximum	Maximum	Minimum
Outer Ring Flame	Maximum	Off	Off

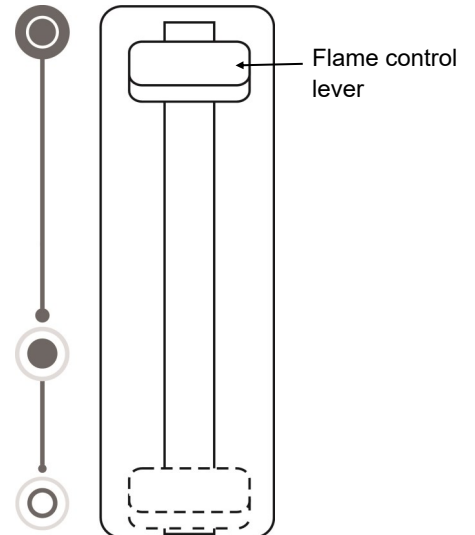

## 3. Turn Off

Press ON/OFF button once. Button returns to OFF position.

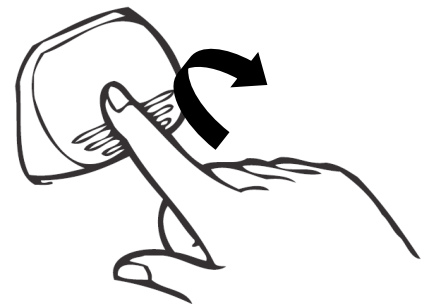

## 4. Accidental Flame Off

If the flame is off unexpectedly, press button once to return to OFF position. Ensure cleanliness of burner before ignite burner again.

If flame holes of burner are blocked, allow burner to cool down and clean it. Wipe it dry before ignite burner again.



## Maintenance

**Attention: Allow the appliance to cool down before performing any maintenance and cleaning. Wear gloves to protect the hands while cleaning.**

To maintain the appliance properly, follow the following instructions to clean it regularly:

- Do not use steam cleaners for cleaning;
- The metal and enameled parts must be cleaned with suitable non-abrasive and non-corrosive detergents. Avoid using chlorine-based detergents (e.g. bleach);
- Avoid leaving acidic or alkaline substances on the appliance (e.g. vinegar, brine, lemon juice);
- Clean and tidy up the appliance after spillage of liquid once it cools down;
- The burner caps must be washed regularly with warm water and detergent. Remove any grime and keep the flame holes of burners away from blockage;
- Dry the burner caps completely after wash and ensure that all flame holes of burner are not clogged;
- Replace burner caps on burner bases correctly. Ensure that they are not tilted or reversed;
- Regularly check the flame failure safety sensors and spark electrodes. In case of sticking with stains, clean them with soft brush.

## Troubleshooting

Some malfunctions can be handled by user. But if the following remedial actions are not effective, please call Towngas Customer Service Hotline at 2880 6988.

<b>Fault</b>	<b>Cause</b>	<b>Remedy</b>
1. No ignition	Spark electrode is wet.	Dry the spark electrode with dry cloth.
	Spark electrode has dirt.	Clean the spark electrode.
	Battery is consumed.	Change battery.
	Battery polarity is wrongly placed.	Place battery correctly.
2. No flame	Gas meter valve and / or appliance gas supply valve is turned off.	Open gas meter valve and/or appliance gas supply valve completely.
	Burner is blocked by aluminum foil.	Remove aluminum foil.
3. Flame cannot be held	Not fully press ON / OFF button.	Fully press ON / OFF button, and hold it for several seconds.
	Flame failure safety sensor has dirt.	Clean flame failure safety sensor.
4. Flame off when using	Small flame is blown off by wind.	Wait for 1 minute, restart ignition.
5. Yellow flame	Burner has dirt.	Wash burner caps in warm water with detergent. Wipe them dry and replace them properly. Restart ignition .
6. Unstable flame	Incorrect placement of burner caps.	After cooling, replace burner caps properly, then restart ignition.
7. Abnormal noise when using	Incorrect placement of burner caps.	Turn off flame. Replace burner caps correctly after appliance cools down and restart ignition.
8. Pop sound when turning off flame	Instant combustion of gas remained in burner.	Normal phenomenon.

## Specifications

Model		UZH1S	UZH1SL	UZH2S	UZH2SL
Gas Type		Hong Kong Town Gas	Hong Kong L.P.Gas	Hong Kong Town Gas	Hong Kong L.P.Gas
Number of Burners		1	1	2	2
Rated Heat Input (kW)	Total	5.8	4.5	11.5	8.8
	Left Burner	-	-	6.0	4.5
	Right Burner	-	-	6.0	4.5
Gas Pressure (kPa)		1.5	2.9	1.5	2.9
Gas Inlet Connection		1/2" B.S.P Male	3/8" Rubber Hose Connector	1/2" B.S.P Male	3/8" Rubber Hose Connector
Overall Dimensions (mm)	Height (To top plate)	128		128	
	Width	290		700	
	Depth (Body)	389		389	
Weight (kg)		3.8		8.0	
Ignition Device		Fast-easy electronic ignition system			
Flame Failure Safety Device		Thermoelectric type			
Power Supply		1.5V D-size battery (1 pc)			



香港中華煤氣有限公司  
**The Hong Kong and China Gas Company Limited**

202204